



Code of Best Practice for Agility Judges and Stewards & Guide to Agility Equipment

This document was updated in **January 2024** with effect for shows on or after **January 2024**.

Code of best practice for agility judges and stewards & guide to agility equipment

1	INTRODUCTION	4
1.1	THE KENNEL CLUB CODE OF CONDUCT	4
2	THE JUDGE	5
2.1	BECOMING A JUDGE	5
2.2	ETHICS AND INTEGRITY	5
2.2.1	Health guidelines	6
2.2.2	Seeking judging appointments	6
2.2.3	Training days	6
2.3	JUDGING CONTRACTS	6
2.3.1	Part 1 – Invitation	7
2.3.2	Part 2 – Acceptance	7
2.3.3	Part 3 – Confirmation	7
2.4	UNABLE TO HONOUR A JUDGING APPOINTMENT	7
2.5	FAILURE TO HONOUR AN ENGAGEMENT	8
2.6	RESERVE JUDGES	8
2.7	MENTORING	8
2.8	OVERSEAS JUDGES	9
3	PREPARING FOR THE COMPETITION - IN ADVANCE	10
3.1	PRIOR TO THE EVENT	10
3.2	COURSE DESIGN	10
3.2.1	Course construction	10
3.2.2	Size of rings	10
3.3	COURSE PLANNING	10
3.3.1	Safe placement of obstacles	11
3.3.2	Timing	12
3.3.2.1	Electronic timing	12
3.3.2.2	Manual timing	12
3.4	PERSONAL ITEMS	12
3.5	APPEARANCE & BEHAVIOUR WHEN JUDGING	12
4	PREPARING FOR THE COMPETITION – AT THE SHOW	14
4.1	ON ARRIVAL AT THE SHOW	14
4.2	BUILDING THE COURSE	14
4.3	PREPARING THE RING FOR COMPETITION	15
4.4	SETTING THE COURSE TIME	15
4.5	HOW TO MEASURE THE COURSE	15
4.5.1	Contact equipment	16
4.5.2	Weaving poles	16
4.5.3	Pipe tunnel	16
4.5.4	Long jump	16
4.5.5	Spread jump	16
4.5.6	Hurdles	16
4.5.7	Hurdles - serpentine, flick flacks, snakes & double pull throughs	16
4.5.8	Wall, wishing well & tyre	16
4.5.9	Measuring back past an obstacle	16
4.6	BRIEFING THE RING PARTY	18
4.7	BRIEFING COMPETITORS	18
4.8	QUERIES FROM COMPETITORS	18
4.9	COURSE WALKING	19
5	THE RING PARTY	20

5.1	RING MANAGER	20
5.2	SCRIME (SCRIBE AND TIMER)	20
5.3	CALLING STEWARD (CALLER)	21
5.4	LEAD STEWARD	22
5.5	POLE PICKERS	22
5.6	TIMER	22
5.7	SCORER	22
5.8	RING PARTY FACILITIES	23
6	JUDGING	24
6.1	GENERAL JUDGING RULES	24
6.1.1	Marking the start and finish	24
6.1.1.1	Start	24
6.1.1.2	Finish	25
6.1.2	Refusals	25
6.2	OTHER FAULTS	25
6.3	ELIMINATIONS	25
6.4	SITUATIONS THAT SHOULD NOT BE FAULTED.	26
6.5	JUDGING SITUATIONS	26
6.5.1	Re-runs	26
6.5.2	When to stop a dog's run	26
6.5.3	Removing a dog from the class	27
6.5.4	Dealing with incidents	27
6.5.5	Restarting a class	27
6.5.6	Handling queries from competitors during judging	27
6.5.7	Abusive behaviour towards judges or ring party	28
6.5.8	Run offs	28
6.5.9	Pausing a class	28
6.6	INCIDENT REPORTING	28
6.7	AFTER COMPLETING JUDGING	29
6.7.1	Record keeping	29
6.7.2	After the show	29
7	EQUIPMENT SPECIFICATIONS & JUDGING/MARKING	30
7.1	HURDLE	30
7.2	BRUSH FENCE	31
7.3	RISING SPREAD JUMP	32
7.4	WALL	33
7.4.1	Securing the wall	33
7.4.2	Marking for the hurdle, brush fence, rising spread jump and wall	33
7.4.2.1	Faults	33
7.4.2.2	Refusals	33
7.4.2.3	Eliminations	34
7.5	TYRE	35
7.5.1	Positioning the tyre	35
7.5.2	Securing the tyre	36
7.5.3	Marking for the tyre	36
7.5.3.1	Faults	36
7.5.3.2	Refusals	36
7.5.3.3	Eliminations	36
7.6	LONG JUMP	37
7.6.1	Positioning the long jump	37
7.6.2	Securing the long jump	37
7.6.3	Marking for the long jump	37
7.6.3.1	Faults	37
7.6.3.2	Refusals	38
7.6.3.3	Eliminations	38
7.7	WATER JUMP	39

7.7.1	Marking for the water jump	39
7.7.1.1	Faults	39
7.7.1.2	Refusals	40
7.7.1.3	Eliminations	40
7.8	WISHING WELL	41
7.8.1	Marking for the wishing well	42
7.8.1.1	Faults	42
7.8.1.2	Refusals	42
7.8.1.3	Eliminations	42
7.9	PIPE TUNNEL	43
7.9.1	Positioning the pipe tunnel	43
7.9.2	Securing the pipe tunnel	44
7.9.3	Marking for the pipe tunnel	45
7.9.3.1	Refusals	45
7.9.3.2	Eliminations	45
7.10	WEAVING POLES	46
7.10.1	Securing the weaving poles	46
7.10.2	Marking for the weaving poles	46
7.10.2.1	Faults	46
7.10.2.2	Refusals	47
7.10.2.3	Eliminations	47
7.11	SEE-SAW	48
7.11.1	Positioning the see-saw	48
7.11.2	Securing the see-saw	48
7.11.3	Marking for the see-saw	49
7.11.3.1	Faults	49
7.11.3.2	Refusals	50
7.11.3.3	Eliminations	50
7.12	'A' FRAME	51
7.12.1	Positioning the A Frame	51
7.12.2	Marking for the A Frame	51
7.12.2.1	Faults	51
7.12.2.2	Refusals	52
7.12.2.3	Eliminations	52
7.13	DOG WALK	53
7.13.1	Positioning the dog walk	53
7.13.2	Marking for the dog walk	54
7.13.2.1	Faults	54
7.13.2.2	Refusals	54
7.13.2.3	Eliminations	54
7.14	POSITIONING OF CONTACT OBSTACLES	56
7.15	TOLERANCES	57
8	CHAMPIONSHIP CLASSES	58
8.1	BECOMING A CHAMPIONSHIP JUDGE	58
8.2	OBSTACLES TO BE USED IN CHAMPIONSHIP CLASSES	58
8.2.1	The agility round	58
8.2.2	The jumping round	58
8.2.3	The final agility round	58
8.3	TIMING	59
8.4	CALLING FOR CHAMPIONSHIP CLASSES	59
9	APPENDIX A - COURSE TIME MATRIX	60
10	APPENDIX B – QUICK REFERENCE GUIDE	63

1 Introduction

This code of best practice is intended to help support Kennel Club approved judges and draws together all the current Kennel Club guidance documents and agility regulations. It also guides judges on the use of agility equipment, how it is judged and the practical aspects of judging.

The guidance should be read in conjunction with the full 'H' Regulations and Kennel Club Codes, and helps to clarify the wording, interpretation and guidance that is published from time to time through easy-to-understand language and diagrams.

The Kennel Club's codes can be found on [The Kennel Club website](#).

1.1 The Kennel Club Code of Conduct

The Kennel Club Code of Conduct sets out the expectations for all those taking part in or attending events under its jurisdiction along with general guidelines on the use of social media.

You can find the Code of Conduct on [The Kennel Club website](#).

The key expectations relevant to agility shows, judges and stewards are detailed in full in the Code of Conduct, and we would specifically draw your attention to items under "people" including conduct, sportsmanship, verbal communications, and abusive or aggressive behaviour supported by our zero tolerance policy.

With regard to the use of social media The Kennel Club Code of Conduct helps you identify and avoid potential issues and provides some examples of best practice which are intended to help you understand, from a wide range of perspectives, the implications of participation in social media and how best to conduct yourself and protect and maintain privacy. Reading of this guidance in full is strongly advised.

2 The judge

2.1 Becoming a judge

Judges appointed at Kennel Club licensed agility events must have completed and passed the Agility Judges examination on The Kennel Club Academy prior to attending a Kennel Club Agility Judges Seminar and passed the assessment.

All judges must have completed and passed the agility judges examination on The Kennel Club Academy every five years since passing the Regulations and Judging Procedure examination. This regulation came into effect from 1 January 2022.

2.2 Ethics and integrity

The overall and stated purpose of The Kennel Club is to make a positive difference for dogs and their owners and judges have a key role to play in assisting with this purpose.

The overall aim and objective of a judge at whatever level, is to provide value for the time, training, effort, and money which the competitor puts into presenting their dog. Moreover, the decisions of judges, and particularly championship judges, will ultimately affect the future development of agility.

There is therefore an expectation that judges will be competent and trustworthy. Judging is not a right, but a privilege and judges should be respected by the competitor. To that end this code sets out the relevant aspects that judges should be capable of demonstrating:

- Judges at Kennel Club licensed agility shows are expected to maintain and abide by the highest standards in accordance with Kennel Club Rules and Regulations and appropriate Codes of Best Practice as published from time to time
- Judges should act honestly and impartially when undertaking an appointment
- Judges are required to have a comprehensive knowledge of competition procedures and etiquette. It is the responsibility of judges to keep up to date with developments in such matters
- Judges should conduct themselves in a manner which is compatible with the standing of a judge at all times whilst at a show and in any other capacity which might have a bearing on the interests of the canine world
- Judges at an agility show may not judge a dog which is recorded in their ownership or part ownership; or handle a dog at the show/competition at which they are judging
- Judges cannot judge a dog which is handled by the scheduled judge's spouse, immediate family or is resident at the same address as the scheduled judge. This shall not apply to judges appointed in an emergency

Judges are referred to the factors set out below which may be said to affect their standing and may result in exclusion from judging lists or future judging contracts or withdrawal from an agreed appointment:

- Criminal convictions
- Threatening behaviour at any time
- Misrepresenting or abusing authority
- Not judging in accordance with Kennel Club Rules and Regulations

- Harsh handling as a competitor or judge at any time
- Breach of Kennel Club Rules and Regulations
- Using the name of The Kennel Club in an unauthorised manner

2.2.1 Health guidelines

Judging can be a physically and mentally demanding task and as such judges should consider the following factors when accepting judging appointments:

- Judges must be able to undertake the judging of dogs with an obvious independence and in a confident and convincing manner. Judges must not at any time rely on others to assist with the main work of judging
- Judges are expected to decline, or to withdraw from, an appointment, which they cannot fulfil. The aim of the competition can only be fulfilled when the judging of dogs is carried out in a fully competent manner
- Judges must be capable of meeting the physical requirements of fulfilling the judging appointment, thus should be sufficiently mobile to move around and judge the dog from all aspects

The show organisers should endeavour to find out that invited judges are able to fulfil their appointments.

Ill health of various kinds can temporarily or permanently make it impossible for a person to complete a judging appointment according to the demands which are set forward in this code of best practice. A society or club can, if necessary, either temporarily or permanently cancel the judging contract should it become apparent that the judge cannot appraise their own situation and can no longer fulfil the judging appointment.

The Kennel Club has an overriding responsibility and may in individual cases either temporarily defer or permanently withdraw approval when the judge in question is considered not to have the necessary capabilities. That is not to say that any particular disability will preclude judging. A common-sense approach needs to be adopted by both show organiser and judge.

2.2.2 Seeking judging appointments

Judges should be approached by clubs or societies for appointments or judges may respond to general requests for judges as put out by clubs or societies. The soliciting of judging appointments is not acceptable. Judges should not approach individual clubs or put pressure on a club to offer them judging appointments.

2.2.3 Training days

Judges are reminded that it is not acceptable to use future judging appointments as a means to attract attendees to an agility training day that they are organising, past judging experience / championship status is permitted to be used.

2.3 Judging contracts

Invitations to judge must be made by the show organisers and must follow the three-part contract. Judges should ensure that all three parts are properly received and that they understand the contract into which they are entering.

2.3.1 Part 1 – Invitation

Organising societies must send out a judging invitation in writing (paper or digitally) to invite a judge, standard wording included within the Judging Contract Regulations must be included.

The invitation will confirm that the appointment will require you to abide by the rules and regulations of The Kennel Club. The organising show may include details of any other restrictions that may affect your decision to judge. You must notify the organising society of any change in your personal circumstances that may affect your ability to judge.

2.3.2 Part 2 – Acceptance

The judge must respond in writing (paper or digitally) that they accept the invitation to judge.

The acceptance is usually accompanied with personal contact details, any specific requirements for classes and details of expenses.

2.3.3 Part 3 – Confirmation

The organising society will provide written confirmation (paper or digitally) of the judging appointment.

A preliminary list of classes to be judged may also be provided at this stage. Upon receipt of written confirmation, the judge is deemed to be under contract to judge at the show.

In all circumstances, digital signatures are acceptable when signing contracts digitally. Any organising society reserves the right to cancel the contract before the date of the appointment if there is a change in personal circumstances, which in their reasonable opinion would adversely affect the judge's ability to fulfil the appointment, or in consultation with the judge.

When accepting an appointment, the judge should note that one person may only judge a maximum of 450 dogs in one day, excluding unforeseen circumstances such as re-runs. When agreeing to the number of classes and type of courses the judge should confirm that they feel able to judge these and consider how many dogs they could reasonably judge on the day.

2.4 Unable to honour a judging appointment

If a judge is unable to honour an appointment, then it is essential that they contact the organisers as soon as possible. This should be put in writing and the judge should ensure that they receive a confirmation from the organising society to confirm this has been received.

Examples of why a judge might not reasonably be able to honour an appointment include ill health or changes to personal circumstances (such as a change in employment or the need to provide social care/support to someone). These are only examples and are not a comprehensive list.

2.5 Failure to honour an engagement

In the event of a club/society or judge failing to honour an appointment, The Kennel Club Board will require reasons why the appointment was not honoured, and in the event of the explanation not being considered satisfactory, the Board may impose a fine.

2.6 Reserve judges

The organising club will normally appoint one or more judges to keep themselves available for judging should a problem arise with one of the scheduled judges. Reserve judges should also receive a contract from the organising club. Reserve judges may be called upon to judge after the schedule has been issued but before the show begins if a judge has had to withdraw.

They may also be called upon during the show, primarily due to the illness of one of the judges.

Reserve judges need to be flexible and capable of taking on a range of different classes.

If they step in to judge on the day, they may be asked to judge a course already set by another judge, although if the class has not started, they may make any alterations they see fit.

When a reserve judge is asked to step in on the day this is categorised as being an “emergency judge”. In this situation the results from any classes they have already competed in should still stand and the regulation relating to not judging members of their own family does not apply.

2.7 Mentoring

The Kennel Club judges’ mentoring scheme is designed to offer support to new and/or inexperienced judges. It is optional, so judges do not have to have a mentor when they first start judging but it is strongly recommended.

Both Kennel Club accredited agility judge trainers and Kennel Club championship agility judges may act as mentors.

The mentor will assist the judge in preparing their course and planning their days judging. If they are available at the show, they may assist with course building and measuring, and supporting the judge while they are judging by being available to answer queries and offering feedback on their course and judging.

A mentor may not compete in any class that is judged by someone they are mentoring that day.

A judge wanting a mentor should contact The Kennel Club by emailing agility@thekennelclub.org.uk well in advance of their judging appointment, ideally as soon as they are invited to judge. The Kennel Club will seek to find a suitable mentor for them. Alternatively, the judge may approach one of these people directly and ask if they will act as their mentor on this occasion.

There is no restriction on any judge, however experienced, seeking out a mentor to support them with any appointment but only accredited trainers and championship agility judges may take on the role of a Kennel Club mentor.

2.8 Overseas judges

Judges from overseas officiating in this country must judge in all respects in the same general manner as is expected of judges resident in the UK. Overseas judges judging at Kennel Club licensed events, should note that they should judge to The Kennel Club Rules and Regulations. The judges' duties in this country cannot be delegated. The suitability of overseas judges to judge at Kennel Club licensed shows will be assessed in the same way as judges who are resident in the UK.

To assist judges from overseas, inviting societies are required to supply them with:

- A copy of Kennel Club Agility Regulations (H)
- A copy of this Code of Best Practice

Overseas judges who are not endorsed by the relevant Kennel Club of their own country will not normally be approved to judge in the UK.

UK judges are reminded when judging overseas that they must conform to the rules, regulations, and conventions of the host country. Judging must be undertaken on the basis of the rules and regulations that are recognised in that country.

3 Preparing for the competition - in advance

3.1 Prior to the event

This section provides guidance on the design of courses, information that the judge should ensure they have in advance of the day and other guidelines to help a judge to prepare for a day's judging.

3.2 Course design

3.2.1 Course construction

The course should require a dog to complete at least 15 obstacles but not more than 20 and all jump obstacles in any class should be the same height.

All obstacles should have a minimum of 5m and up to a maximum of 10m between centres of consecutive obstacles using the straight-line centre-to-centre method (as described in this document).

Standard agility classes must include the 'A' frame, dog walk, see-saw, and weaving poles. Standard jumping classes must include the weaving poles.

In the event of extreme adverse weather conditions at the show, the judge, with the full agreement of the competition manager, may alter the compulsory equipment as deemed appropriate at the time. Any alterations to the equipment must be recorded in the incident book and reported by the management to The Kennel Club within 14 days of the date of the show.

3.2.2 Size of rings

The test area shall have a suitable surface and measure a minimum of 32m x 32m for outdoor rings. Indoor rings are recommended to be 600 square metres but must be a minimum of 450 square metres with no one side measuring less than 15m. For outdoor all-weather arenas of one or more rings that are enclosed by structure, fence, or permanent barrier each ring is recommended to be 800 square metres but must be a minimum of 600 square metres with no one side measuring less than 20m.

All indoor and outdoor all weather permanently enclosed rings for Prestige Events and/or Championship classes must be a minimum of 800 square metres with no one side measuring less than 20m. The ring area includes space for officials, including the scime and ring party, but where possible the ring tent should be outside the ring area.

Judges should confirm with the competition manager or show secretary the size of ring that they will be using in advance of designing their courses. At the show, the judge should check that the ring they use meets the regulation on ring size before starting to lay out their course.

3.3 Course planning

The course should be designed by the judge in advance of the competition. The judge is responsible for the design of the course and **must** at all times give total consideration to the safety of the dog.

The judge will take the following into account when planning their course:

- The judge should fully appreciate and consider safe positioning of equipment and anticipated paths of travel for dog, handler, and judge
- The planned judge's path should take into account having clear views of the dog and equipment at all times (especially tunnel entrances and exits, contacts, weaves, long jump, and tyre), enabling the scime to see the judge's hand signals and the distance to be travelled
- A consistent judging path is essential
- The anticipated handler's path should be considered and how it may affect the planned judge's path
- The anticipated dog's path should be based on the line of approach and the speed of approach from the previous obstacles
- The grade of the dogs should determine the skill set the judge tests
- The height of dogs should be considered when planning the dog's probable line and approach to each obstacle
- Consideration should be given to the line most dogs will take, not the line the judge would prefer the dogs to take. The judge should also identify where handler error might send the dog on an inappropriate or dangerous path and should mitigate against this
- Any restrictions or constraints notified in advance by the show organisers should be taken into account such as ring size, ring entrance location, adjacent hazards, ring fencing, ring confines etc.
- Sufficient space must be allowed at the start of the course to enable the dog to be setup by the handler within the ring. Dogs must not start from outside the ring. The first obstacle must be set a minimum of 5m from the edge of the ring, measured along the dog's most likely path when taking the obstacle, taking into account the dog's likely path from obstacle 1 to 2
- The course design should, where possible, avoid repeating the first or last obstacles to avoid the potential for timing problems
- The finish must be placed in such a way to enable the handler to gain control of their dog before exiting the ring. The space from the last obstacle to the edge of the ring measured along the dog's probable line should be a minimum of 5m
- Consideration should be given to the placing of the start and finish in relation to each other to enable queuing of dogs waiting to enter the ring to be safe and away from ring entrances and exits
- Consideration should be given to the proximity of the start and finish obstacles to avoid dogs taking the first jump again after completing the final jump

3.3.1 Safe placement of obstacles

The priority for judges designing a course is the safety of dogs, handlers, and ring party.

The dog's path onto and off obstacles must be carefully planned accordingly. There are a number of considerations as to what is a safe approach, including the angle and speed that the dog is travelling from the previous obstacles.

Guidelines on the recommended position of contact obstacles, the tyre and the long jump are given in the Equipment Specifications in this document.

Judges should also take into account the likely path of handlers and, where possible, place obstacles so that there is a safe route for handlers around the course avoiding potential trip hazards.

3.3.2 Timing

The only obstacles allowed at the start and finish of a standard agility or jumping course are the hurdle, wall, spread jump, brush jump, long jump, tyre, wishing well and pipe tunnel.

3.3.2.1 Electronic timing

Electronic timing gates should be positioned within 30cm in front of the first obstacle and within 30cm after the last obstacle.

The distance between the electronic timing gates should be no less than the width of the part of the obstacle the dog has to negotiate. Whenever possible the timing gates should be placed within the width of the hurdle wings, or in the case of the wall, within the pillars. For the long jump, tyre, wall, wishing well, pipe tunnel, the timing gates should be placed as close as possible to the outside edge of the obstacle without impeding the dog's natural path.

3.3.2.2 Manual timing

The above applies when manual timing is used in conjunction with start/finish poles. Start/finish poles should not be placed in advance of the first obstacle or beyond the last obstacle.

If manual timing is used the judge must brief the timer. The judge should decide on where the timer should stand to record the start and finish. The judge determines if start and finish poles are to be used or if part of the obstacle is to be considered as the markers (such as the wings of a hurdle).

The time should be started when any part of the dog passes through the agreed start gates. At the finish, the time should be stopped when any part of the dog passes through the agreed finish gates.

3.4 Personal items

When preparing to judge, it is advisable for the judge to carry the following:

- Course plans – printed or digital
- An up-to-date copy of the agility H Regulations – printed or digital
- An up-to-date copy of this document - printed or digital
- Measuring wheel
- Tape measure
- Suitable footwear for the ground conditions
- Protection from the weather such as a hat, sunglasses, sun cream, waterproofs
- Any personal items you might need, such as medication

Ensure that you have all these ready for your day's judging.

3.5 Appearance & behaviour when judging

When judging it is essential that the judge:

- Judges all competing dogs in a confident, careful, and consistent manner
- Dresses in an appropriate manner and is easily identifiable.
- Should not smoke or consume alcoholic drinks whilst in the ring, at ringside or judging
- Should not eat in the ring at any time



- Should not use a mobile telephone when judging. Mobile telephones should be switched to silent or turned off when judging
- Does not engage in conversation with competitors or spectators during judging

The eligibility of dogs entered in any class is not the concern of the judge or ring party. Any queries or concerns should be referred to the competition manager.

4 Preparing for the competition – at the show

4.1 On arrival at the show

The judge should ensure that the competition manager or show secretary knows that they have arrived and check if there are any specific instructions for the day.

It is worth checking:

- When any refreshment breaks will be
- What arrangements are in place for prize giving
- What briefings for competitors are to take place
- Identify all relevant stewards including the scime, ring manager and, if appropriate the timer.
- If you arrive prior to your judging day, you may need to check in with the show secretary on the day of judging as well as when you first arrive

4.2 Building the course

Judges may need to adjust pre planned course designs on the day if ground conditions or weather dictate to ensure the safety of the dogs, handlers, and the judge.

The judge may be able to build the course the day before or may rely on others to lay equipment out ready for them to complete the course building.

Before course building it is recommended that the judge checks the following:

- That the size of the ring meets the required minimum standards and is the size anticipated
- That there is sufficient space between rings or that there is appropriate fencing between the rings
- The nature of ring fencing and any adjacent hazards
- Location of ring entrance and exits, ensuring adequate space has been provided between rings with appropriate fencing
- Location of the ring tent
- Location of crating area, if allocated, ensuring it does not interfere with competitors or ring party
- Is the ring surface safe?

Some of these may not be as the judge anticipated. Some may be adjusted, such as placement of ring tents, entrances & exits. In other cases, the course may need to be adapted to accommodate the ring as provided.

The judge is advised to speak to the competition manager if they require any alterations or the ring is in any way unsuitable.

Once the course has been built the judge alone may, if they wish, run a dog in their ownership around the course for the specific purpose of checking the course's suitability, confirming the dog's lines or handler's path. The judge may not allow anyone else to test their course.

The judge should also walk around the course to confirm their judging path.

The judge should not put out any course numbers in advance of the show opening and the course being ready for walking. The exception is where the start and finish are marked to enable electronic timing to be set up.

The judge should ensure that course layout and all equipment adhere to The Kennel Club H regulations and is, where appropriate, secured in the recommended way.

4.3 Preparing the ring for competition

On arrival at the ring the judge should ensure that the ground conditions and other environmental factors are still suitable for the course as set out. The judge should check that all equipment is still where it was positioned and that all obstacles are secured appropriately.

Where electronic timing is used this should be checked by the judge to ensure that it is set correctly at the start and finish and is working correctly.

Once the judge and ring party have finished with any course preparation, the course should be measured, and the numbers should be set out in position ready for the course to be walked. It is not advisable to position obstacle numbers in temporary locations as these will have to be moved prior to the class starting and do not enable competitors to see where the numbers will be. If there is no safe place for the number for the weaves to be placed this should be placed at the front of the weaves during walking and then removed when the class starts.

If the judge asks other people to help with setting out the course, they must thoroughly check the placement of all the obstacles themselves.

4.4 Setting the course time

The judge shall calculate an appropriate course time for each class, considering the course length, the height category of the dogs competing, and the grade or grades of the dogs competing in the relevant class, together with any other relevant factors, such as ground conditions and weather.

The judge must measure the course length using a commercially available measuring wheel, using the straight-line distance between obstacle centres method (as described in the 'How to measure the course' section). The judge may then use the standard time matrix (given in Appendix A) to guide them to the appropriate course time.

Judges are advised not to increase the recommended course time from that given in the matrix unless there are conditions on the day that would make this necessary. Judges should make sure that the course time is available to competitors before judging starts.

4.5 How to measure the course

The total course length must be measured, by the judge, using the straight-line distance between obstacle centres method. The instructions below explain how different obstacles should be measured and this is illustrated in the diagrams that follow.

4.5.1 Contact equipment

Measure to the centre bottom of the up plank. Lift the wheel and place it beside the obstacle and measure to the end of the “off” contact area. Lift the wheel and place it at the centre bottom of the down plank. Measure to the centre of the next obstacle. Do not measure over the obstacle.

4.5.2 Weaving poles

Measure to the first weaving pole and then in a straight line to the last weaving pole. Do not measure in and out of the poles. Measure alongside the poles in a straight line. Measure to the centre of the next obstacle.

4.5.3 Pipe tunnel

Measure to the tunnel entrance. Lift the wheel and place it to the outer side of the tunnel entrance. Measure around the back of the tunnel (as close as possible to it) to the tunnel exit. Lift the wheel and place it at the centre of the tunnel exit. Measure to the centre of the next obstacle.

4.5.4 Long jump

Measure to the centre of the first element of the long jump. Lift the wheel and measure along the side of the long jump to the last element. Lift the wheel and place at the centre of the last element of the long jump. Measure to the centre of the next obstacle.

4.5.5 Spread jump

The spread jump is best measured with the poles removed. Measure through the centre of the two sets of wings. Measure to the centre of the next obstacle.

4.5.6 Hurdles

Hurdles are best measured with the poles removed. Always measure through the centre of the wings (at the centre of the pole). Where this is not possible (for example the approach angle is shallow/obscure) then measure to the wing’s edge and then to the centre of the pole. Measure to the centre of the next obstacle.

4.5.7 Hurdles - serpentines, flick flacks, snakes & double pull throughs

Measure from the centre of the first hurdle to the centre of the last hurdle in a straight line. This can be measured from either side of the hurdles.

4.5.8 Wall, wishing well & tyre

Measure to the front centre of the obstacle. Lift the wheel and place beside the obstacle and measure along the side of it. Lift the wheel and place it at the centre of the other side of the obstacle. Measure to the centre of the next obstacle.

4.5.9 Measuring back past an obstacle

Measure from the centre of the obstacle to the outside of it. Measure to the centre of the next obstacle.

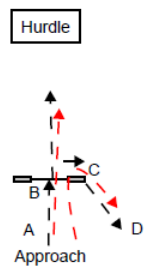
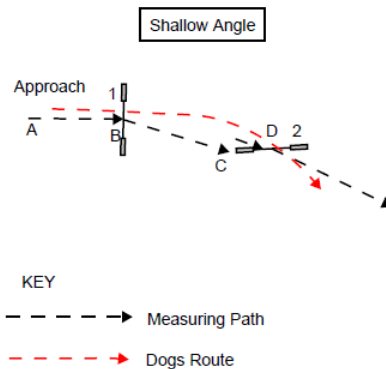
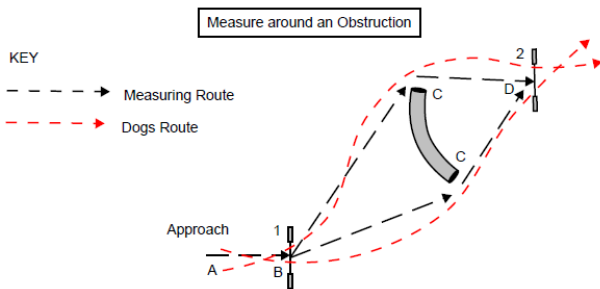
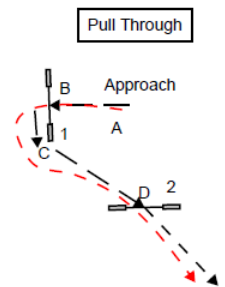
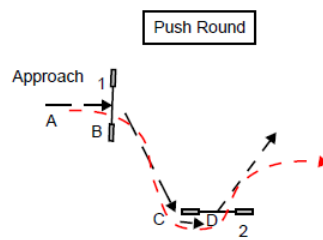
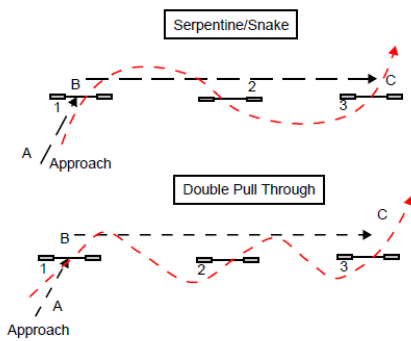
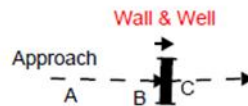
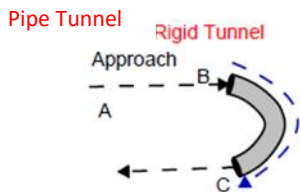
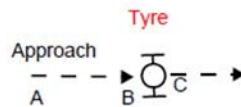
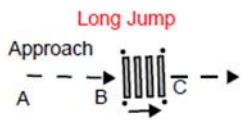
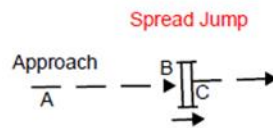
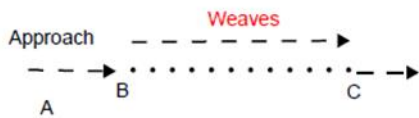
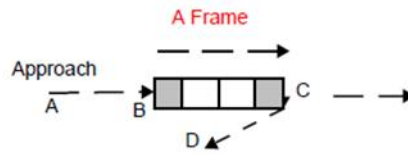
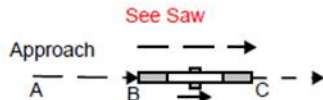

4.6 Briefing the ring party

The judge should ensure that the ring party is fully briefed on how they would like the ring to be run. This is normally done by briefing the scime and ring manager. The ring manager should then ensure that these instructions are passed on to all members of the ring party throughout the day.

The judge should consider briefing the ring party on:

- Checking weave poles, tunnels, the see-saw, and any other obstacles that might move as a number of dogs traverse them
- Whether they wish the ring party to enter the ring at any time to rebuild obstacles when the dog is still running
- How they would like the queue of dogs waiting to run to be positioned
- If there are any areas where spectators should not be allowed to stand/sit beside rings
- When the next competitor should be allowed to enter the ring to prepare to start
- The positioning of handler's personal possessions at the end of the course
- How they will signal to the scime they are ready for the next dog to start
- What hand signals they will be using to mark dogs if different from standard
- How and when the scime should notify them of any timing failure
- When they would like to take breaks during the day
- How and when the ring manager should approach them if a competitor has a query while the class is running
- Any rules relating to special classes, especially those that affect running orders

4.7 Briefing competitors

Judges should ensure that competitors are briefed where there are special rules for a class (typically for special classes such as pairs, teams or snooker) where there may be a deviation from standard Kennel Club marking or dogs may need to compete in a particular order. The judge should ensure that the course time is clearly stated for competitors.

Judges may brief competitors verbally (over a tannoy or by the ring side) or in writing (through notices at ringside).

4.8 Queries from competitors

The judge should make themselves available prior to the class starting should there be any queries from competitors. This is normally done ring side as course walking starts or when the class is about to start.

If a competitor queries the course that the judge has set the judge should make their own decision if the queries are valid, bearing in mind the rules in The Kennel Club H regulations and guidance offered in this document. If the judge wishes to discuss the issue, they should approach the competition manager.

Course design is the decision of the judge alone – they should not discuss course design with anyone other than the competition manager, their Kennel Club mentor (if one has been appointed) or a judge from another ring that day.

Anyone seen to be moving equipment without permission of the judge should be reported to the competition manager and recorded in the incident book.

4.9 Course walking

No practice is allowed on the course. Competitors will be allowed to walk the course set at the correct height for the dog they are running without their dog(s) before the class begins.

Judges should ensure that they allow an appropriate time for course walking that takes in to account the number of competitors needing to walk the course, any clashing classes, and the layout of the venue.

It is good practise to make sure that the start time for each class is communicated to competitors when the course is ready for walking.

In special classes the height of the hurdles may be raised/lowered, and the length of the long jump and width of the rising spread may be extended/reduced, within the permitted ranges, during the course walking time if multiple heights are offered within the same class.

5 The ring party

An effective ring party is critical to the efficient and successful running of an agility show. Most agility shows rely on volunteers to work as ring party and are grateful for all help that is offered. No qualifications are needed to get involved and even those with limited experience of agility shows can help.

It is important that anyone carrying out ring party duties understands their role and responsibilities, but most roles can easily be taught by shadowing other ring party members.

All the ring party will usually help with setting up and changing courses during the day but there are important individual roles. The roles described are not a definitive list and sometimes jobs can be shared, or one person can do more than one job.

Everyone should be welcomed to be part of ring parties and there are jobs that everyone can do no matter their age, mobility, or experience. Where children are part of the ring party extra consideration should be given to their safety ringside and they should be given appropriate supervision.

5.1 Ring manager

The ring manager is responsible for the smooth running of the ring including but not limited to the following tasks:

- Allocating tasks to their ring party
- Showing new ring party members what to do
- Ensuring the judge's requirements are met
- Organising meal breaks and food for judges, scime and other members of the ring party
- Coordinate the course-walking, ring progress announcements and queries or problems

Ideally the ring manager should be the same person throughout the day, however, if the role is shared then communication at handover is crucial.

5.2 Scime (scribe and timer)

The scime is responsible for recording the judges marking of each dog by noting the judge's hand signals to indicate any faults or eliminations.

These will be recorded on an electronic tablet or a paper slip. Only faults indicated by the judge should be recorded. The scime must not eliminate a dog for any reason unless the judge indicates an elimination.

The scime can also be responsible for confirming the correct handler is on the start line by calling the name on the tablet or paper. The judge will indicate to the scime when they are ready and the scime will tell the handler that they can start. Hand signals can be used if the handler requests.

If a judge opts to use a whistle to start the dog, then the judge must confirm the scime is ready. Some shows may not allow whistles, and this should be checked in advance of the appointment. Hand signals may be required as well as the whistle.

The scime also acts as the timer and is responsible for recording the time for each dog by noting the time recorded by the electronic or manual timer.

The job of scime can be demanding as it requires concentration for extended periods of time, along with the ability to multi-task and maintain accuracy.

The scime must watch the judge and record all faults indicated. If the scime has a query about a dog's run the judge should be consulted before the next dog run.

The judge should brief the scime in advance to ensure that the scime knows how the judge works; what hand signals they use, how the dogs should be started and the procedure for queries or timing failures.

If more than one scime is being used throughout the day, then the judge should be aware and have briefed all scimes.

5.3 Calling steward (caller)

The caller's role is to call competitors to the ring to ensure the smooth running of the class, book them in and ensure the correct competitor is ready to run.

- Competitors should be called to the ring by their running order.
- Competitors are usually called in blocks of 10 or 20 to manage the queue.
- The caller books in competitors with their running order or name.
- Callers are responsible for communicating the number the ring is currently calling to by updating the ring boards, electronic system or by tannoy announcements.
- Competitors should only be allowed to run out of order in a class if they are helping at the show, running more than one dog in the class, or are running in a championship class at the same time.
- The handler's name may be changed when booking in but not the dogs. Grades should not be changed either.
- All incidents of incorrect dog details should be referred to the show secretary.

Callers are responsible for marking competitors as present and ready to run on their tablet or paper list. These competitors queue outside the ring waiting to be called for their run.

When competitors are nearing the front of the queue the calling steward will move them to the formal queue and keep them in order ready for the scime to record their results.

This queue should be kept short but also ensure that there is always a competitor on the line ready so that the class is not held up waiting for competitors.

The caller will also signal to the next handler when they may enter the ring for their run.

The caller will also ensure that it is announced when the class is being called to the end. This is a warning to competitors who have not run that they need to come to the ring.

A final call should be given to warn competitors the class will close in a few minutes.

The judge will confer with the caller when making the decision to close the class, looking at how many dogs did not run and when the final calls were made. Only the judge is permitted to decide that a class can be closed.

Once the class is closed it may not be opened again and only run-offs may be done.

5.4 Lead steward

The lead steward is responsible for moving the dog's lead from the start line to the finish line for the handler to collect. The judge will indicate where leads should be placed at the finish.

It is normal for this task to be shared between several helpers.

5.5 Pole pickers

The pole picker's job is to replace and readjust obstacles displaced during a dog's run or between runs. The judge will provide a briefing of how and when they wish this to be done.

Pole pickers will usually be seated at the side of the ring while the class runs.

Each ring will usually require a minimum of two pole pickers.

5.6 Timer

Different from the scime, a timer will be required when manual timing is being used. A manual timer is always used in championship classes and sometimes a judge may deem it necessary in other classes.

The timer will use a manual stopwatch, starting when the dog negotiates the first obstacle and stopping when it completes the last obstacle.

The judge will brief the timer on where they should stand at the start and finish and precisely when the stopwatch should be started and stopped.

It is important that the timer does not obstruct the view of the judge or scime while ensuring that they are in the correct position.

The judge may request the timer to start a dog's run, at which point the timer must confirm the judge and scime are ready before starting the dog. The stopwatch is still only started when the dog negotiates the first obstacle.

The timer should not be changed during a class to ensure consistency.

5.7 Scorer

If paper slips are being used to record runs, then a scorer will be required to process the slips.

Scorers will be based either in the ring tent or a central scoring area. If a central scoring area is being used, then runners will be needed to take the slips from the ring to the scorers.

Scorers enter results onto a score sheet for the class, either manually or electronically.



Scorers will usually have a system for checking off slips that have been entered and sorting the slips to enable checking if there is a query.

The scorer must let the ring manager or caller know if there are any run-offs for places required immediately once the class has finished. It is therefore essential that the scorer keeps on top of the results coming in.

A scorer must never alter a slip or make assumptions about any unclear marks or missing data. Queries must be referred to the scime for the ring who will advise or consult with the judge if necessary.

5.8 Ring party facilities

Ring parties should normally be provided with a ring tent or other ring side shelter. This enables the Scime to sit out of the sun or wind and rain and provides a base for helpers to put their personal belongings. Clubs will normally provide refreshments for ring parties such as drinks or snacks ringside to keep them going through what can be a long and tiring day.

Members of the ring party should make sure that they do not consume food in the ring (even between classes) and that any food in the ring tent is kept covered so as not to attract the attention of dogs in the ring.

6 Judging

6.1 General judging rules

Judges are not permitted to make any public commentary on the dogs whilst judging.

Judges should ensure that all faults and eliminations are clearly indicated so that the scime and competitor are in no doubt that a fault or elimination has been awarded. Judges' signals must be deliberate and clear, signals should be held long enough to ensure the scime has enough time to check they have recorded the fault without missing another fault. It is recommended that judges use alternate arms when signalling consecutive faults to help assist scimes. Commonly a refusal is marked with a raised arm and closed fist, five faults by a raised arm and an open hand and an elimination by crossed arms. It is normal practice to clap any clear rounds.

All marking on each obstacle is cumulative and a dog can therefore be faulted multiple times on the same obstacle. For example, in the weaves a dog can be faulted for both a refusal and coming out of the weaves or on the seesaw a dog can be faulted for both missing the contact on exit and for exiting the plank before it has touched the ground.

The judge must observe the dog at all times whilst it is in the ring, even after elimination. If the judge has stopped marking the dog (due to elimination) they must still, ensure that they have a good view of the dog until it has completed the course and leaves the ring. The judge must never turn their back on the dog when it is still in the ring.

The judge must ensure that they follow a consistent path when judging all the dogs so that they have a similar view of each dog negotiating obstacles.

The judge should not turn to look at the scime or check that they have recorded faults during the dog's run. If any checks need to be made these should be done when the dog has left the ring.

If a dog leaves the ring while it is competing the judge should do their best to watch where the dog goes and what happens, in case there is an incident.

6.1.1 Marking the start and finish

The dog and handler are deemed to be under test when instructed by the judge or the judge's scime, by signal or voice. "Under test" course marking does not start until the dog has made an attempt at taking the first obstacle. Therefore, the handler may return to their dog to reposition it and touch it without being faulted during this time. However, some rules apply the whole time the dog is in the ring, both before and after they are tackling the course. These include fouling the ring and feeding the dog. The test has concluded when the dog has negotiated the last obstacle, or the handler and dog have voluntarily left the ring.

6.1.1.1 Start

The handler may place their dog anywhere they wish on the course to take the first obstacle. This includes starting the dog on the far side of the first obstacle and sending them back around that obstacle to take it.

If the dog runs by the first obstacle it should be faulted with a refusal.

Starting prior to instruction from the judge or scime may result in elimination.

6.1.1.2 Finish

If the dog runs by the final obstacle, it should be faulted with a refusal.

Failure to complete the final obstacle will result in elimination.

6.1.2 Refusals

Information on how to mark refusals on specific obstacles is given in [section 7](#).

General rules on refusals are that the judge should:

- Give a refusal if the dog runs past the line of the front of the obstacle, or, for the Dog Walk or A Frame if the dog runs past the furthest point of the ascending ramp, for the see saw if it passes the line of the end of the up contact.
- Give a refusal if the dog turns away in front of an obstacle, when in position to negotiate it
- Ensure that decisions on refusals are consistent throughout a class

6.2 Other faults

Five faults should be given if:

- The handler deliberately touches any piece of equipment or their dog

If the handler does touch the dog the judge must determine if the contact is accidental or intentional. Accidental contact should not be faulted.

Any physical disciplining of the dog by the handler in the ring or any uncontrolled behaviour of the dog must be penalised by adjusting the dog's score and the judge may bar the dog from further competition in the class. If this occurs, then the incident must be recorded in the incident book.

6.3 Eliminations

An elimination should be given if:

- The dog is deemed by the judge to be out of control. This is usually taken as running out of the ring and not in control. A dog that briefly leaves the ring and then returns to its handler or heads straight to a groom or other known person would not normally be deemed out of control. A dog that runs to the edge of the ring to 'challenge' or attack another dog or spectator should be considered to be out of control. All incidents of a dog out of control should be recorded in the show's incident book
- A handler knocks an obstacle, causing the pole to drop or in any other way changing an obstacle, prior to the dog taking the obstacle, as the dog cannot complete the course in the correct manner
- The dog takes the wrong course
- The dog has a total of three refusals on the course
- The dog fails to touch the ascending ramp on the Dog Walk or A Frame.
- The dog fouls the ring. This applies the moment the dog enters the ring to compete and applies until the dog has left the ring
- The dog is wearing an incorrect style of collar. A single, close fitting collar is permitted, providing the only attachment is a plain identification panel as an integral part of the collar. i.e. not attached by a ring

- The handler traverses over, under or through any piece of equipment
- The handler wears a bag or has a lead around them when under test
- Any food is given to the dog whilst in the ring
- The handler carries anything in their hands, other than a mobility aid, whilst the dog is under test
- There is any double handling or deliberate assistance given to a competitor whilst competing from either inside or outside the ring, this might include assistance at the start (including releasing the dog at the start from a training aid) verbal cues or encouragement given to the dog by anyone other than the handler
- Any deliberate handling that helps the dogs complete an obstacle

It is usual for a dog to be allowed to continue once it has been eliminated, but it is permissible, and sometimes necessary, for the handler to be asked to leave the ring, once the course time has been reached. This may be stated during the judge's briefing.

6.4 Situations that should not be faulted.

- A dog is permitted to wear "stopper pads" when competing. These can be to protect the pads or dew claws and can be made of any material
- Handlers must never be penalised for using necessary mobility aids in the ring
- Judges should not fault a dog that accidentally takes an additional obstacle after completing the last obstacle

6.5 Judging situations

6.5.1 Re-runs

Re-runs are awarded entirely at the judge's discretion. Re-runs might be offered when the run has to be stopped or abandoned due to outside interference. If it is not possible to record the dog's time for any reason (such as timing failure or the timer resetting) the judge may offer a re-run immediately or they may decide only to offer a re-run later if the dog has a chance to be placed.

Should the judge deem a re-run is required, any result and/or faults gained in the previous run must be discounted.

6.5.2 When to stop a dog's run

The judge should only ever stop a handler and dog once their run has started for safety reasons. Examples of when this might occur are:

- When an obstacle that the dog is due to negotiate is potentially dangerous
- When another dog has entered the ring and poses a danger to the dog, handler, judge, or ring party
- The judge believes that the dog may be injured or that continuing might be detrimental to its health
- An incident has occurred outside the ring that might pose a danger to the dog, handler, judge, or ring party
- If the handler has been handling the dog harshly

After a dog has been stopped it is the judge's discretion as to whether the handler is given the chance to complete the course, offered a re-run or asked to leave the ring.

6.5.3 Removing a dog from the class

If a judge believes that allowing a dog to continue to compete is likely to cause suffering to the dog, then the judge should not allow the dog to continue to compete in the class. The judge should inform the handler of their decision and the dog will be dismissed from the ring. The judge should then discuss the dismissal and their reason with the competition manager who will determine what further action (if any) should be taken. This must always be recorded in the incident book.

6.5.4 Dealing with incidents

The judge is ultimately responsible for anything that happens in their ring when judging. Judges should be prepared to manage a wide range of incidents that might include:

- Injury of a handler/dog
- Out of control dog
- Harsh handling of a dog
- Aggression by a dog towards people or dogs
- Damage to or failure of equipment

The judge should also be aware that disruption outside the ring (for example by vehicles, spectators, dogs) might require a class to be stopped.

The judge should always stop competition while the incident is dealt with and only resume the class if it is safe and appropriate to do so. The judge should assume control of the situation, calling for assistance from the competition manager as needed.

All such incidents should be recorded in the incident book. If there is any doubt in the judge's mind, then the incident should be recorded in the incident book. The incident book should be completed by the judge at the show, either at a break during the day or at the end of the days judging. The competition manager or show secretary can then collate other additional information shortly after the incident. If, for any reason, this is not possible then the judge may send a report directly to The Kennel Club, copying in the organising club if possible.

6.5.5 Restarting a class

If a class has to stop part way through for any reason, there are several options available. Decisions as to what action is to be taken should be made jointly by the judge and the competition manager. If there is a change of judge or any course change or equipment removed, then the class cannot just continue; it must either be split into two parts or restarted from scratch.

Splitting results is the best option if a significant number of dogs have already run. If a class has to be restarted from scratch the judge should make some significant change to the course so no advantage is given to the handlers and dogs who had already run in that class.

6.5.6 Handling queries from competitors during judging

During judging handlers should not approach the judge directly if they have a query but should approach the ring manager who will then draw the judge's attention to this in a timely manner

No competitor may impugn the decision of the judge(s) and therefore it is not normal for a competitor to question a judge about how the course was marked.

Any verbal communication with a judge should take place after judging has taken place and must be conducted in a polite and professional manner. The judge should not consider any video, photographs or other similar material supplied by a competitor. The judge can only consider what they have seen while judging.

The judge may wish for the ring manager or scime (or their mentor, if they have one) to listen to any conversation in case there are any queries about this at a later date. Again, such discussions may need to be recorded in the incident book.

6.5.7 Abusive behaviour towards judges or ring party

Abusive or aggressive behaviour towards anyone at the show – including the judge, other participants, show management or other officials - will not be tolerated under any circumstances.

No-one should be subject to intimidation or made to feel alarmed or distressed or put in fear of reprisal. Harassment is a criminal offence. To that end, The Kennel Club adopts a zero-tolerance approach towards all type of harassment activity. Harassment may be defined as causing alarm, distress and anxiety and fear of physical violence or other threat, offensive statements, verbal abuse, and threats. Such conduct may include speech, obstruction and so on. As such conduct may involve a criminal offence, the police may be involved, and it may be that The Kennel Club will defer any action pending the outcome of such investigation and/or prosecution.

6.5.8 Run offs

Run offs will only usually take place when there is a tie for an award. However, if the class is a qualifier, it may be that points will be awarded to places for which the club is not giving out awards. In these circumstances a run off may also take place. This may also apply to the qualifying rounds in championship classes.

The run off is only to determine the relative placing of the dogs in the run-off and does not alter their placing in the class other than this.

A good attempt to notify handlers that they are required for a run off should be made (normally over the show tannoy or other announcement system) and a short period of time allowed for them to collect their dogs and return to the ring. If only one dog competes in the run off, then they should be awarded the higher place.

6.5.9 Pausing a class

If the judge determines that it is necessary to pause the class at any point in time, (if a break is needed for example to enable the judge and ring party to shelter from the weather), then competitors should be told how long it is expected to pause for and given ample opportunity to return to the ring when the class restarts.

6.6 Incident reporting

The judge must ensure that any relevant incidents that have occurred in their ring are recorded in the incident book. The incident book must record everything that happened that is out of the ordinary, even if no further action is required. As a judge

you should expect to need to report things in the incident book and this should not be seen as a criticism of your competence as a judge or of the show management.

Examples of things that may need recording include:

- Dog out of control (whether a bite occurs or not)
- Harsh handling
- Trips or falls resulting in injury
- Delay in classes starting, or the need to restart a class
- Problems with equipment (whether this results in removing equipment or not).
- Queries made by competitors over any results

The judge should assist the competition manager in ensuring that full details are recorded including witness names and statements.

6.7 After completing judging

After judging all judges should ensure that they thank their scime and ring party. They should ensure that they have completed all prize givings required by the club.

The judge should check with the competition manager before leaving the show.

6.7.1 Record keeping

It is important for all judges that they keep records of all their judging experience. The Judges Record Book (Agility) is available to enable judges to keep such records and can be signed by the competition manager or secretary to confirm the record.

This is of particular relevance to those hoping, at some future date, to be invited to award Kennel Club Agility Certificates. It is a requirement of The Kennel Club when being asked to award Agility Certificates for the first time that judges complete a questionnaire detailing their experience. Accuracy in completing this questionnaire is essential and the judge signs to that effect. Therefore, it is necessary that judges retain schedules and/or record books showing the actual number of dogs entered and actual number of dogs judged for completing the questionnaire.

6.7.2 After the show

Judges may publish copies of their courses if they wish after their day's judging. Judges should not publicly discuss the decisions they made in relation to marking individual dogs.

7 Equipment specifications & judging/marking

Obstacles – The following obstacles meet with the approval of the Board of The Kennel Club.

7.1 Hurdle

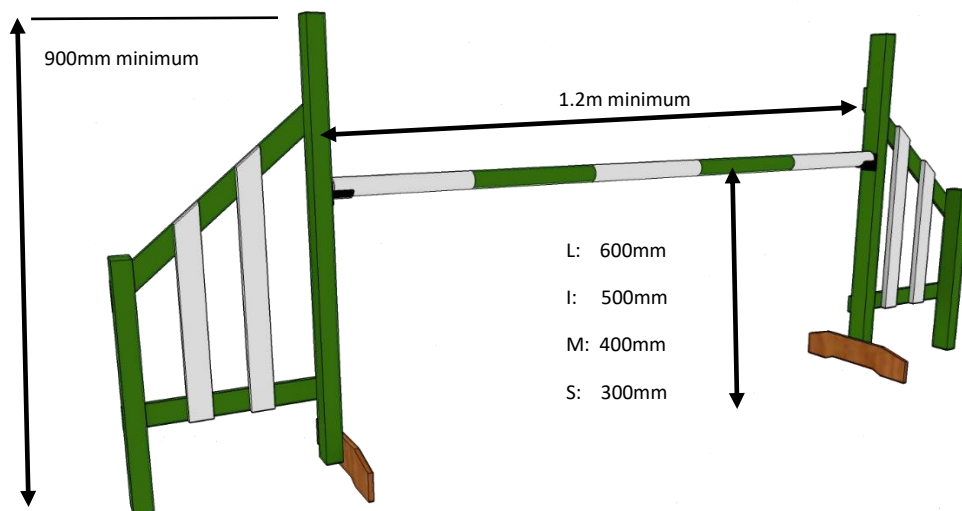

The height of the hurdle must be:

Large: 600mm
Intermediate: 500mm
Medium: 400mm
Small: 300mm

Width: 1.2 m minimum.

All bars, planks and fillers must be easily displaced by the dog. The inner upright of the wings must be a minimum of 900mm with no unnecessary protrusions. No jump cups other than those being used by the current pole height may be on the wings. The height of hurdles in special classes may be lower than those listed above, but the height(s) must be included in the schedule.

7.2 Brush fence



Dimensions and details are the same as for the Hurdle (see section 7.1). This obstacle must have an easily displaceable top unit.

7.3 Rising spread jump

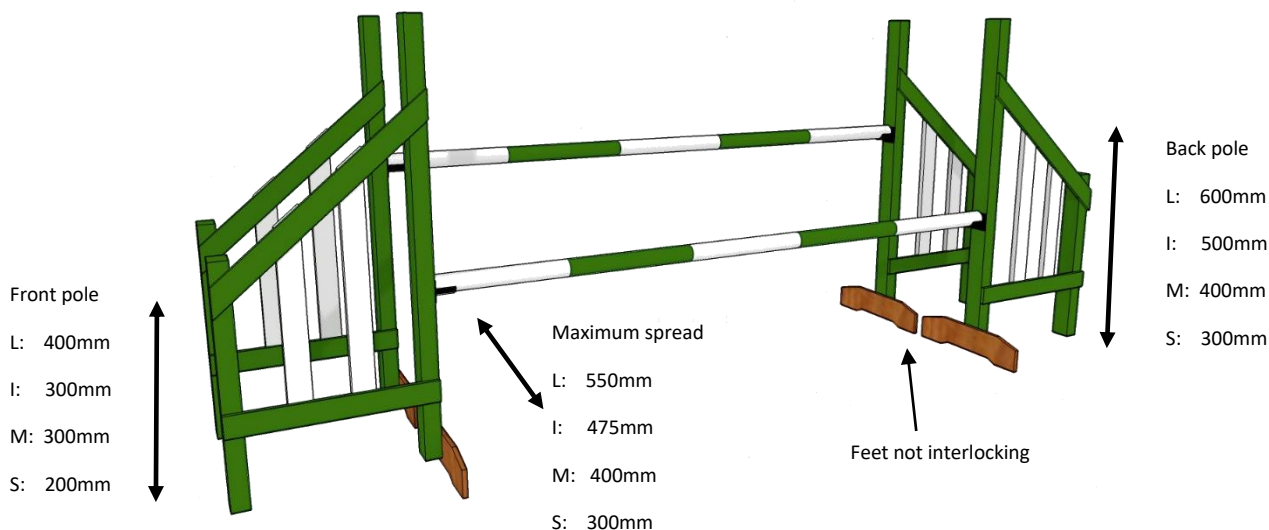

The maximum spread must be:

- Large: 550mm
- Intermediate: 475mm
- Medium: 400mm
- Small: 300mm

A maximum of 2 single jumps (hurdles) placed together to form a double spread, there must be no more than 2 elements to this obstacle.

The top bar on the first hurdle must be 400mm for Large Dogs, 300mm for Intermediate Dogs, 300mm for Medium Dogs and 200mm for Small Dogs.

There must only be one pole on each hurdle. The feet of the side supports (wings) should not be interlocking but can be touching and must not be out of line by more than 75mm.

7.4 Wall

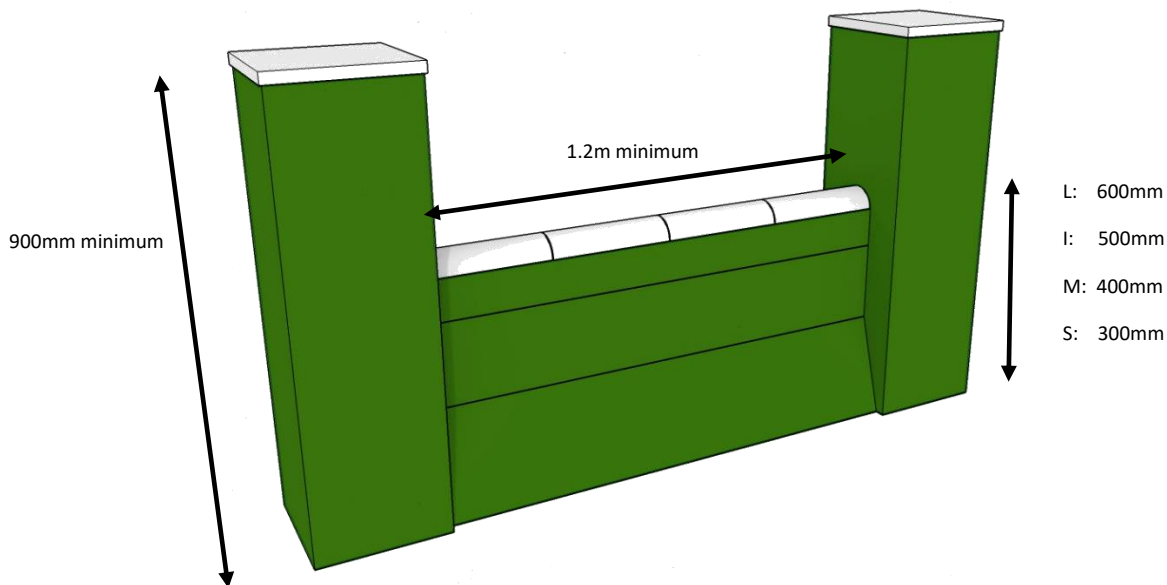

The height of the wall must be:

Large:	600mm
Intermediate:	500mm
Medium:	400mm
Small:	300mm

Width: 1.2m minimum.

All central units must be easily displaced by the dog and not interlocking with the pillars. Pillars with a minimum height of 900mm must be used.

7.4.1 Securing the wall

The pillars of the wall should not be pegged or secured to the ground.

7.4.2 Marking for the hurdle, brush fence, rising spread jump and wall

7.4.2.1 Faults

Five faults should be given if:

- Any of the bars/bricks are displaced (including bars that are lowered but do not fall to the ground, for example if the jump cup moves)
- The wings or pillars are knocked over by the dog or handler

A dog should not be faulted if any part of the obstacle is touched and does not fall.

7.4.2.2 Refusals

A refusal should be given if the dog:

- Runs under the bar
- Jumps the wing/pillar
- Runs past the line of the wings/pillars
- The dog stops or turns away when in a position to jump the obstacle

Examples of refusals are shown in the diagram below.

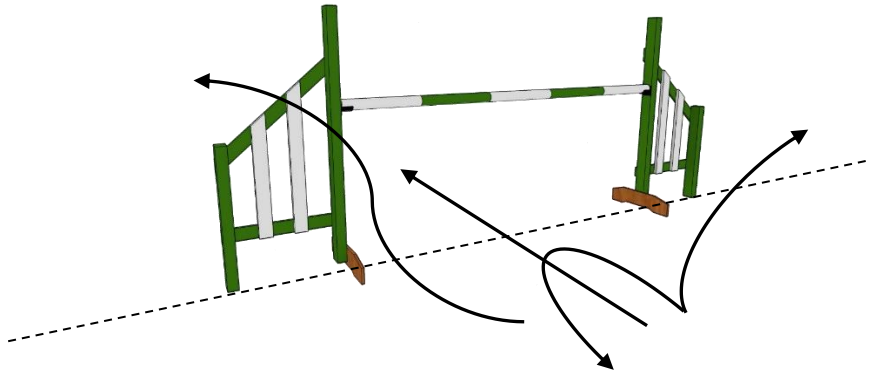

7.4.2.3 Eliminations

An elimination should be given if:

- The obstacle is knocked over by the handler before the dog reaches it. The dog should be eliminated, as it cannot complete the course in the correct order
- The dog jumps or runs under the hurdle in the wrong direction, does not correct a refusal or takes the obstacle out of sequence

7.5 Tyre

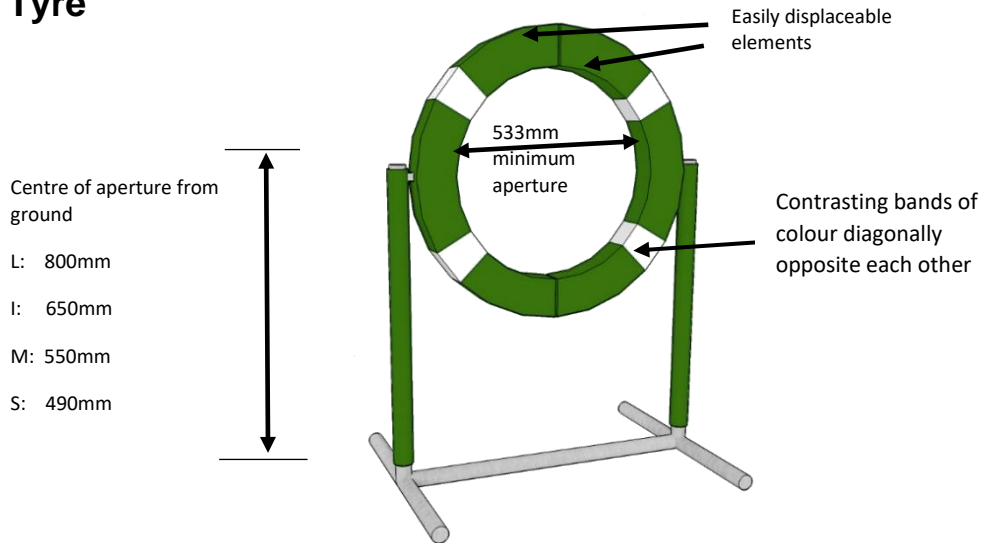

The aperture centre of the tyre from the ground must be:

Large: 800mm
Intermediate: 650mm
Medium: 550mm
Small: 490mm

Aperture diameter 533mm minimum.

The tyre to be of a consistent shape, constructed of an impact-absorbing material. All tyres should have bands diagonally opposite each other in contrast to its basic colour or segments in contrasting colours. The tyre must be directly mounted in a substantial frame structure which must be secured in such a way that dogs cannot easily knock the obstacle over from either direction; the frame shall not have a beam across the top. All tyres must have easily displaced element(s). For saloon style tyres, both opening sides must have an ability to swing open to 90-140 degrees from the closed hoop position. They must not self-return and must be manually re-set.

7.5.1 Positioning the tyre

The tyre should be positioned so that the dog has a straight approach to the tyre. It is also advisable for the dog to have a straight exit or a turn of not more than 90 degrees in either direction after this obstacle as shown in the diagram below.

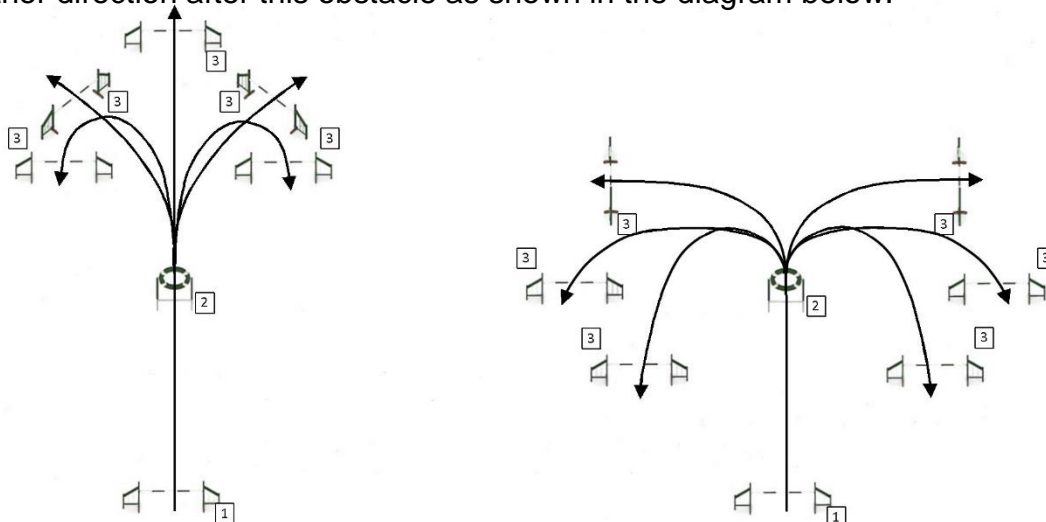

Acceptable line after the tyre

Unacceptable lines after the tyre

7.5.2 Securing the tyre

The tyre should be pegged or secured to the ground with sandbags if it is likely to be unstable.

7.5.3 Marking for the tyre

7.5.3.1 Faults

Five faults should be given if the dog:

- Displaces any part of the breakaway part of the tyre (displacement means that any one of the breakaway portions are displaced from their correct position, there does not need to be daylight visible)

7.5.3.2 Refusals

A refusal should be given if the dog:

- Goes under, or over the tyre, or hits the tyre and falls back
- Runs past the line of the tyre, stops, or turns around when in a position to jump the tyre

7.5.3.3 Eliminations

An elimination should be given if the dog:

- Runs or jumps back through any part of the obstacle
- Displaces any part of the tyre without negotiating it making it impossible for it to be negotiated successfully
- Jumps the tyre in the wrong direction, does not correct a refusal or takes the obstacle out of sequence

7.6 Long jump

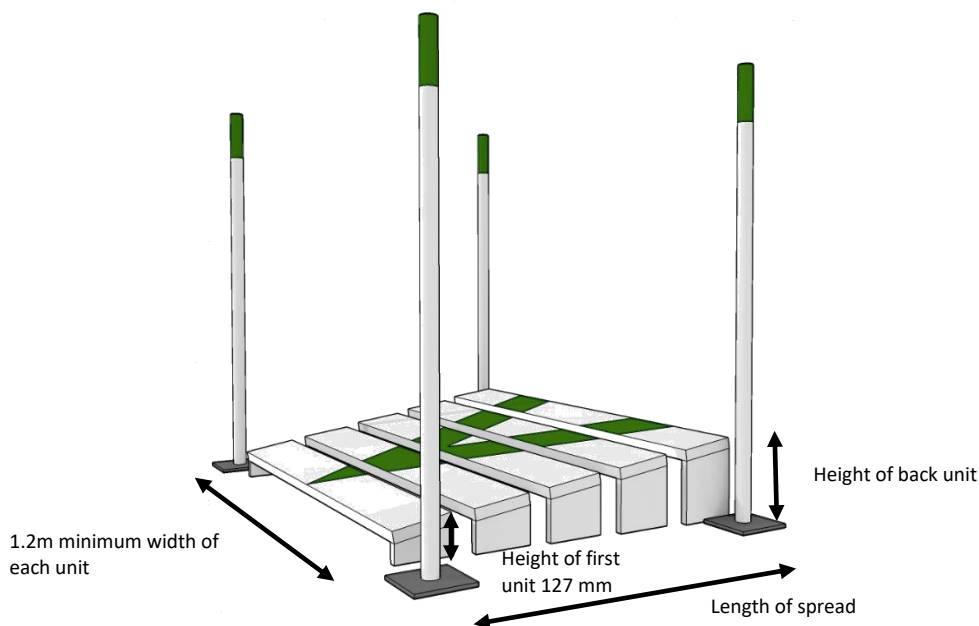

	No. Units	Units	Length	Height of rear unit
Large	5	1, 2, 3, 4 & 5	1.3-1.5 m	381 mm
Intermediate	4	1, 2, 3 & 4	1.0-1.2 m	305 mm
Medium	3	1, 2 & 3	700-900mm	229 mm
Small	2	1 & 2	400-600mm	170 mm

Each unit must be a minimum width of 1.2m.

The height of the front unit must be 127mm.

Marker poles with a minimum height of 1.2m should be placed at all 4 corners, these should not be attached to any part of the obstacle.

7.6.1 Positioning the long jump

The long jump should be positioned so that the dog has a straight approach to it.

7.6.2 Securing the long jump

The long jump should not be pegged or secured to the ground.

7.6.3 Marking for the long jump

A clean attempt should be made to clear the obstacle. Casual contact will not be faulted.

7.6.3.1 Faults

Five faults will be given if the dog:

- Knocks down one or more elements

No faults shall be given if the marker poles are knocked but the dog correctly passes between the poles.

7.6.3.2 Refusals

A refusal should be given if the dog:

- Runs past the long jump
- Jumps in and out to the side of the marker poles
- Walks on or between the elements where no attempt has been made to clear the obstacle

7.6.3.3 Eliminations

An elimination should be given if:

- The obstacle is knocked over by the handler before the dog reaches it. The dog should be eliminated, as it cannot complete the course in the correct order
- The dog jumps the long jump in the wrong direction, does not correct a refusal or takes the obstacle out of sequence

7.7 Water jump

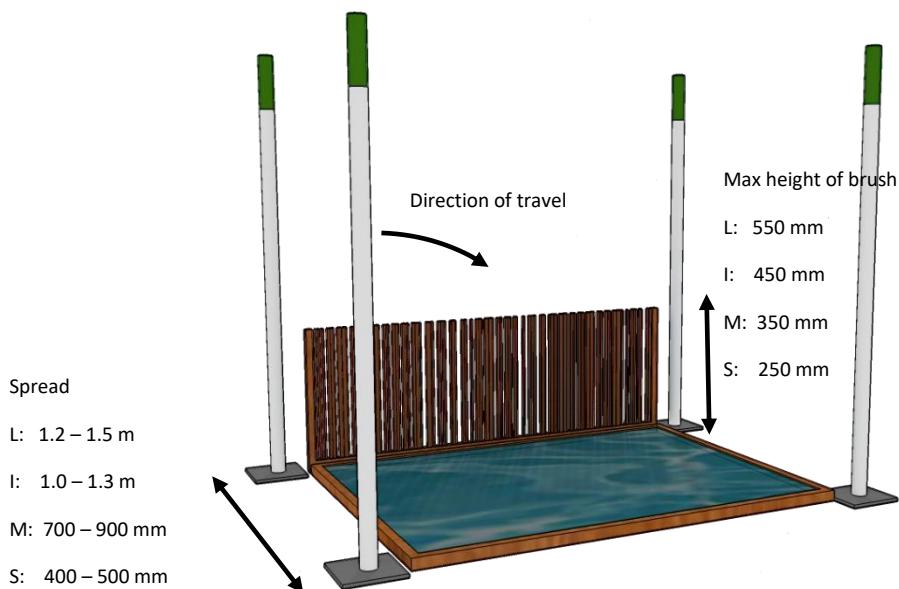

The overall spread should be:

- Large: between 1.2m and 1.5m.
Intermediate: between 1m and 1.3m.
Medium: between 700mm and 900mm.
Small: between 400mm and 500mm.

A low hurdle or brush may be placed in front of the water. This must have a maximum height of:

- Large: 550mm.
Intermediate: 450mm.
Medium: 350mm.
Small: 250mm.

Marker poles with a minimum height of 1.2m, should be placed at all 4 corners, these should not be attached to any part of the water jump.

7.7.1 Marking for the water jump

A clean attempt should be made to clear the obstacle.

7.7.1.1 Faults

Five faults will be given if the dog:

- Knocks down the hurdle or brush in front of the water (if one is used)
- Makes contact with the water

No faults shall be given if the marker poles are knocked but the dog correctly passes between the poles.

7.7.1.2 Refusals

A refusal should be given if the dog:

- Runs past the water jump
- Jumps in and out to the side of the marker poles

7.7.1.3 Eliminations

An elimination should be given if:

- The obstacle is knocked over by the handler before the dog reaches it. The dog should be eliminated, as it cannot complete the course in the correct order
- The dog jumps the water jump in the wrong direction, does not correct a refusal, or takes the obstacle out of sequence

7.8 Wishing well

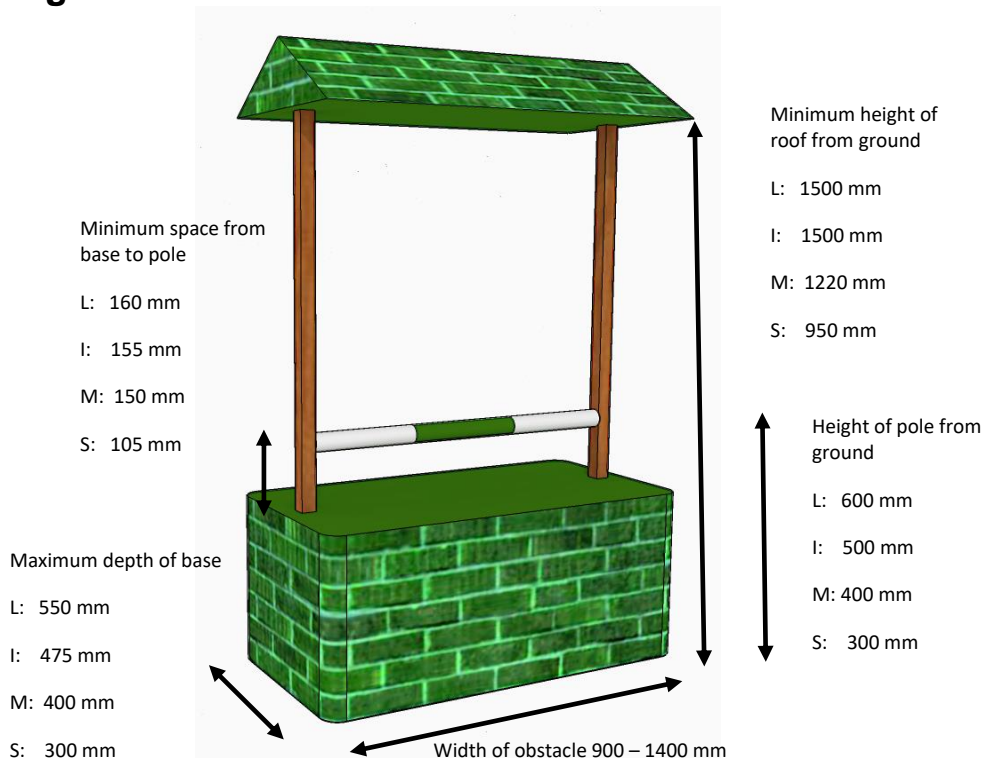

This obstacle will be of stable construction and will be able to be fixed to the ground. To ensure the safety of the dog, it will have no sharp edges. Should a design be used which involves a removable centre section then the resultant corners must be rounded or padded.

It will have a roof, the bottom of this must be a minimum from the ground of:

Large: 1500mm
 Intermediate: 1500mm
 Medium: 1220mm
 Small: 950mm

The roof must not project beyond the width or depth of the base.

It will have a displaceable top bar the height of which will be:

Large: 600mm
 Intermediate: 500mm
 Medium: 400mm
 Small: 300mm

The minimum space from the top of the bar to the top of the base must be:

Large: 160mm
 Intermediate: 155mm
 Medium: 150mm
 Small: 105mm

The overall width of the base will be between 900mm & 1400mm.

The depth of the base which the dog jumps will be a maximum of

Large: 550mm

Intermediate: 475mm

Medium: 400mm

Small: 300mm

7.8.1 Marking for the wishing well

7.8.1.1 Faults

Five faults should be given if:

- The pole is dislodged
- The dog puts its feet on top of the base

7.8.1.2 Refusals

A refusal should be given if the dog:

- Jumps under the bar
- Runs past the line of the wishing well
- The dog stops or turns away when in a position to jump the wishing well

7.8.1.3 Eliminations

An elimination should be given if:

- The obstacle is knocked over by the handler before the dog reaches it. The dog should be eliminated, as it cannot complete the course in the correct order
- The dog dislodged the pole in an attempt to complete the obstacle. The dog should be eliminated as the obstacle can no longer be completed correctly
- The dog jumps the wishing well in the wrong direction, does not correct a refusal or takes the obstacle out of sequence

7.9 Pipe tunnel

This obstacle should have a diameter of a minimum of 600mm and should be a minimum of 3m in length.

Tunnels made of half non-slip material should not be used, until such time as research on non-slip materials is completed.

7.9.1 Positioning the pipe tunnel

The tunnel may only curve in a single direction and the curve should be appropriate for the length of tunnels, with any tight bends avoided. When positioning the tunnel the curve should be measured using the straight line centre to centre method along the inner curve as shown by the dotted line in the diagram below:

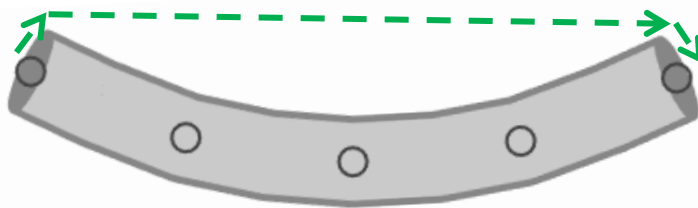

Tunnel Length	Minimum centre to centre distance when curved
6m	5m
5m	4m
4m	3.5m
3m	Do NOT curve. Keep as straight as possible.

NOTE: The tunnel should still be measured around the back to calculate course length.

The tunnel should be fully stretched out with no bunching & this should be regularly checked. The tunnel should only curve in a single direction & the bend should be evenly distributed throughout the length of the tunnel. 3m tunnels should not be curved & should be secured as straight as possible.

Examples of Unacceptable Tunnel Curve



The bend has not been evenly distributed throughout the length of the tunnel. This applies to all tunnel lengths.



3m tunnels should not have a curve but be as straight as possible.



The centre-to-centre straight line measurement is less than the minimum accepted distance. This applies to all tunnel lengths.

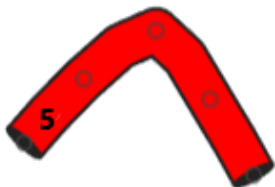

The bend has not been evenly distributed throughout the length of the tunnel and the centre-to-centre straight line measurement is less than the minimum accepted distance. This applies to all tunnel lengths.

When tunnels are used under a dog walk, A frame or near walls indoors, care should be taken to ensure that the tunnel will not hit them. Judges must ensure that no part of the tunnel is touching or might touch another object.

7.9.2 Securing the pipe tunnel

Tunnels should always be fully extended when in the desired shape. The tunnel must be secured to avoid movement. It is recommended that one strap per metre, plus one, should be used. The straps should cover multiple coils and should not be fastened in a way that reduces the diameter of the tunnel. Metal cradles and bungee cords must not be used.

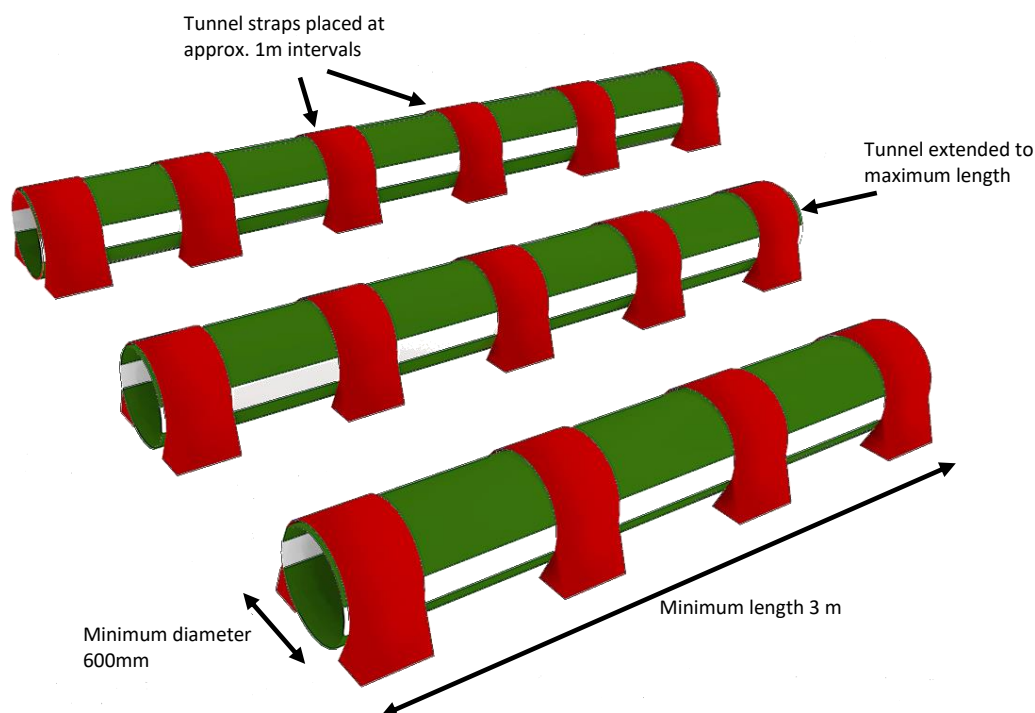

7.9.3 Marking for the pipe tunnel

7.9.3.1 Refusals

A refusal should be given if the dog:

- Runs past the line of the front of the tunnel
- Enters the tunnel and comes back out of the same entrance
- Jumps over the tunnel when attempting to complete the obstacle

7.9.3.2 Eliminations

An elimination should be given if the dog:

- Enters or touches the wrong entrance to the tunnel
- When not attempting the tunnel as the next obstacle, a dog jumping over the tunnel during a round is normally dealt with as wrong course and therefore an elimination.

When the tunnel is under a piece of contact equipment it is important to note that the order of obstacles affects how the dogs should be marked.

If the tunnel is the next obstacle and the dog passes the entrance of the tunnel, and in doing so passes under the contact equipment this should be classed as a refusal. The dog returning to the handler under the contact is also classed as part of the same refusal and should not be given any additional faults (see diagram below).

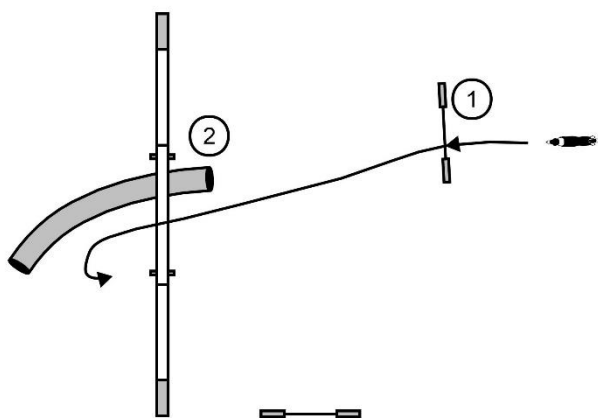

If the tunnel is not the next obstacle and the dog follows the line of the tunnel under the contact, then this would be an elimination (see diagram below)

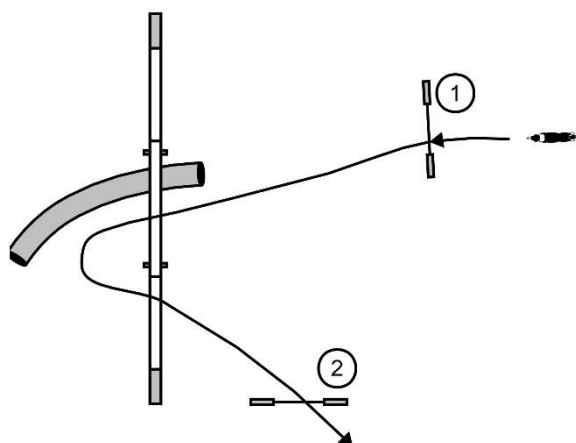

7.10 Weaving poles

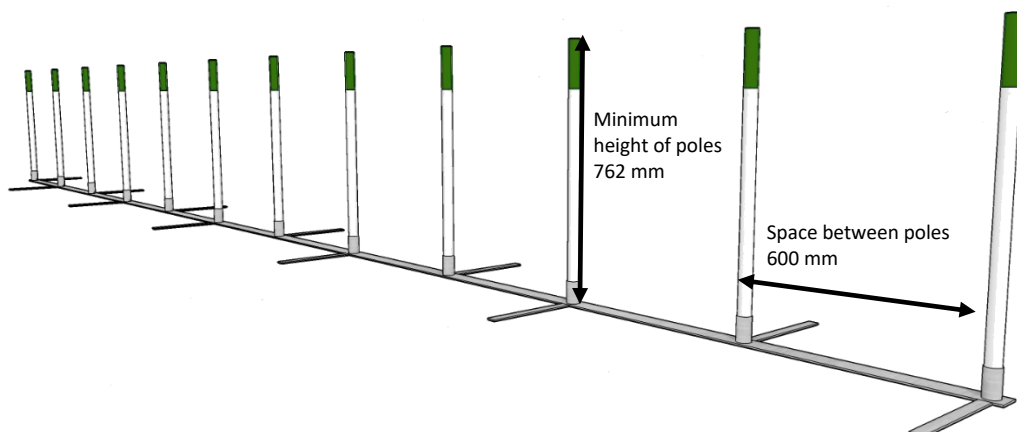

The number of poles should be 6 or 12. The maximum number of weaves in a standard class is 12. A judge can therefore choose to use either a set of 6 poles, a set of 12 poles or two sets of 6 poles. No other variations are permitted.

They should be in a continuous line, as straight as possible and should be 600mm apart (between the poles). The poles must be of rigid construction and with a minimum height of 762mm and a diameter of 35 mm.

The base must have support bars at the bottom of each pole, and they must be positioned away from the side a dog would normally negotiate each pole.

7.10.1 Securing the weaving poles

The weave pole base must be stable and should not move when the obstacle is being negotiated by a dog. Therefore, the weave base should either be heavy weight or be pegged down. Where pegs are used these should be placed so as not to create any protrusions on the base that the dog may have to traverse.

7.10.2 Marking for the weaving poles

The dog must enter the weaving poles with the first pole adjacent to its left side.

7.10.2.1 Faults

Five faults should be given if the dog:

- Comes out of the weave poles after it has made a correct entry

A maximum of five faults can be given on this obstacle for coming out of the weaves. This means a dog can only incur one unit of five faults for errors in completing the weaves (excluding refusals); further errors should not be given faults. However, any touching of the dog, i.e., by knee or hand should be faulted with 5 faults as usual. The dog may be put back into the weaves at the exact point it left and complete the weaves from this point, or it may return to the start and complete the weaves from the beginning.

7.10.2.2 Refusals

A refusal should be given if the dog:

- Runs past the entry line of the weave poles
- Enters the weave with the first pole on its right side
- Does not enter the weaves between the first and second poles (i.e., enters further down the weaves)

Each incorrect entry should be marked as a refusal, with an elimination once a dog has collected 3 refusals.

7.10.2.3 Eliminations

An elimination should be given if:

- The dog fails to complete the weaves correctly before negotiating any further obstacle
- The dog runs back through the weaving poles whilst negotiating the obstacle, (this is suggested as running back through two “gates” not just passing through the poles once in the wrong direction)
- Any deliberate handling is given to help the dog through the weaves
- If the dog crosses through the weave poles at any time when not attempting to negotiate the weaves

7.11 See-Saw

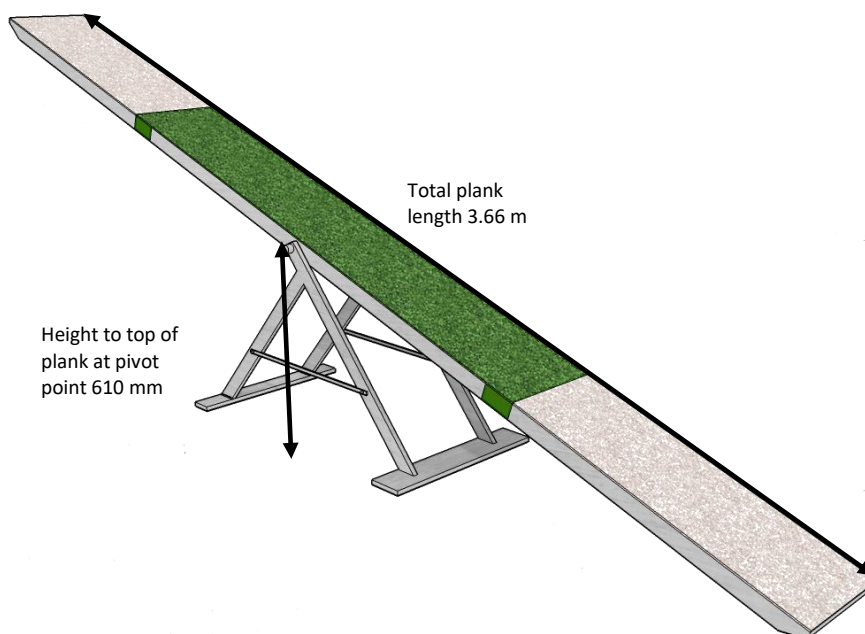

The see-saw will consist of a plank firmly mounted on a central bracket. The length of the plank must be 3.66m. The width must be between 295mm minimum and 305mm maximum. The height at the pivot point must be 610mm from the ground to the top of the plank.

The maximum distance from the pivot point to the top of the plank should not be more than 100mm. The last 914mm from each end should be a different colour to indicate the area with which the dog should make contact. The plank should have a non-slip surface with no slats.

The see-saw must start to tip and then touch the ground between 2-3 seconds after a weight of 1kg has been placed in the middle of the down contact area.

7.11.1 Positioning the see-saw

Entry onto the see-saw should be reasonably straight. Consideration should also be given to the line of exit to ensure that the risk of the dog being caught by the see-saw after alighting is minimized.

7.11.2 Securing the see-saw

The base is normally secured either by pegging the base into grass or the use of sandbags. It is important that the base is not able to lift at both ends, although the approach side of the frame may lift a small amount as the dog tips the see-saw.

7.11.3 Marking for the see-saw

7.11.3.1 Faults

Five faults should be given on the see-saw if:

- The exit end of the plank is not touching the ground before the dog alights from the obstacle
- The dog does not make contact with the up contact area
- The dog alights before touching the down contact area

The dog must touch the contact areas with at least one paw or part of a paw.

Examples are shown in the diagram below.

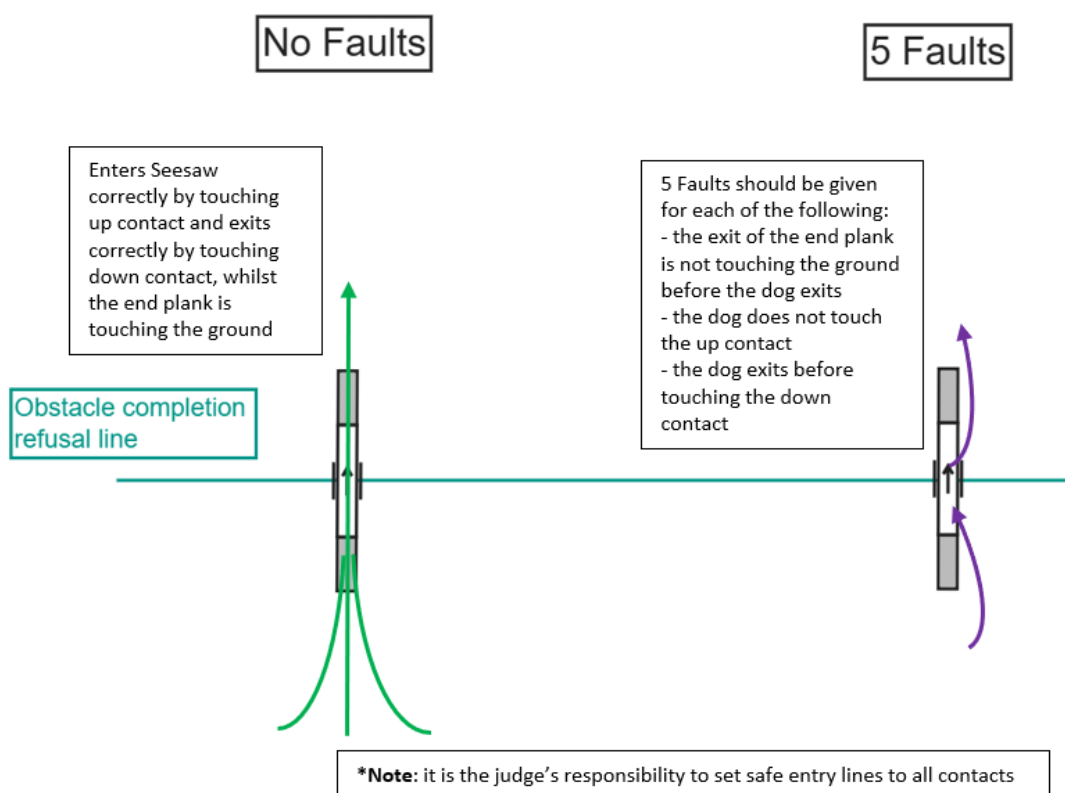

7.11.3.2 Refusals

A Refusal should be given if the dog:

- Stops or turns away when in a position to take the obstacle
- Runs past the line of the up contact area
- Alights before the pivot point on the see-saw

7.11.3.3 Eliminations

An elimination should be given if the dog:

- Touches the obstacle from the wrong direction
- Leaves the obstacle, and then puts a paw back onto the obstacle

A judge should always ensure that they are in such a position that the up and down contacts can be properly judged.

Examples are shown in the diagram below.

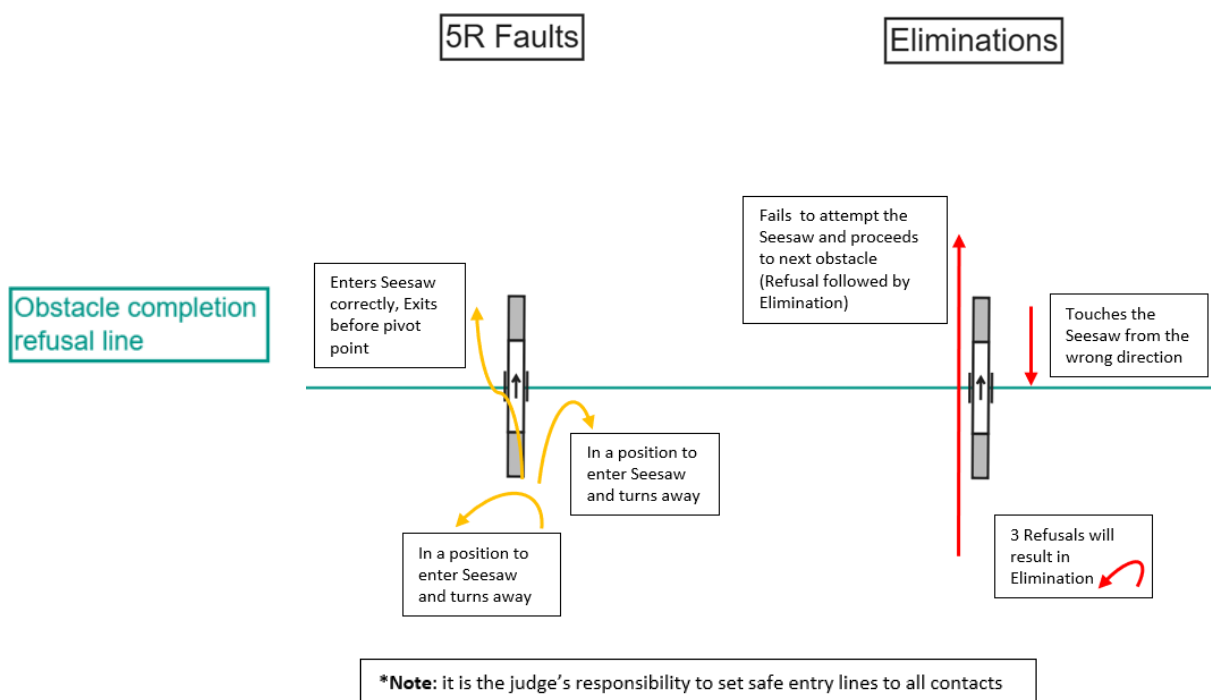

Obstacle completion refusal line: This is the pivot point of the see-saw.

7.12 'A' Frame

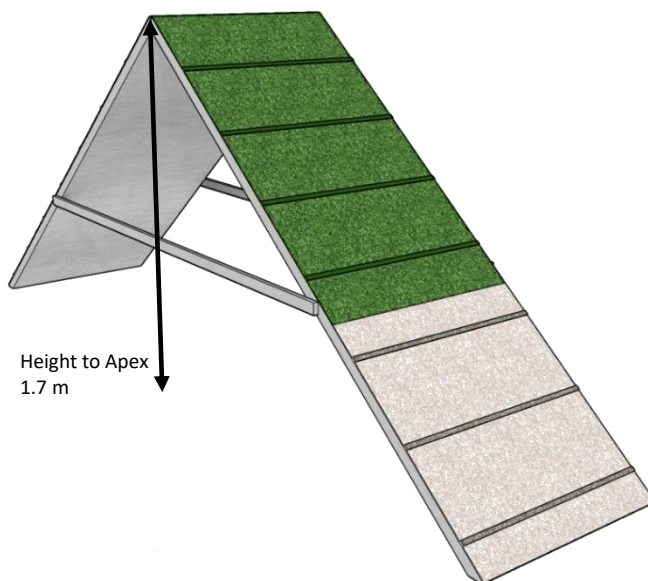

The A frame must comprise of two ramps, 2.74m long by 914mm wide, hinged at the apex 1.7m from the ground. The last 1.067m from the bottom of each ramp should be a different colour to indicate the area with which the dog should make contact. Each ramp to have a non-slip surface, and anti-slip slats at intervals but not within 152mm of the start of the contact area.

7.12.1 Positioning the A Frame

Entry onto the A frame should be reasonably straight.

7.12.2 Marking for the A Frame

7.12.2.1 Faults

Five faults should be given if:

- The dog fails to make contact with the down contact area, the dog must touch the contact area with at least one paw or part of a paw.

Examples are shown in the diagram below.

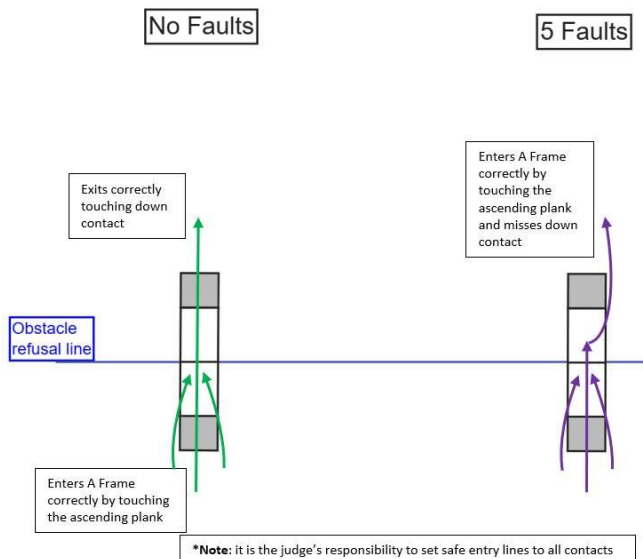

7.12.2.2 Refusals

A refusal should be given if the dog:

- Stops or turns away when in a position to take the obstacle
- Runs past the furthest point of the ascending ramp
- Alights before the down ramp or plank

7.12.2.3 Eliminations

An elimination should be given if the dog:

- Touches the obstacle from the wrong direction
- Leaves the obstacle, and then puts a paw back on the obstacle
- Fails to touch the ascending ramp

Examples are shown in the diagram below.

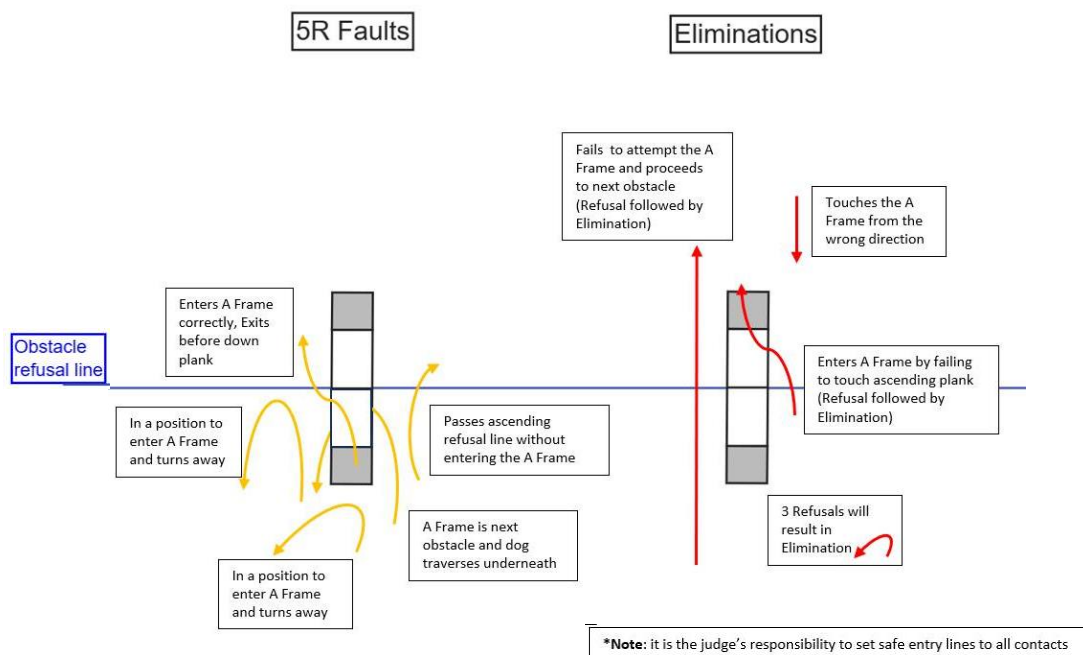

Obstacle refusal line: This is the apex of the A frame.

7.13 Dog walk

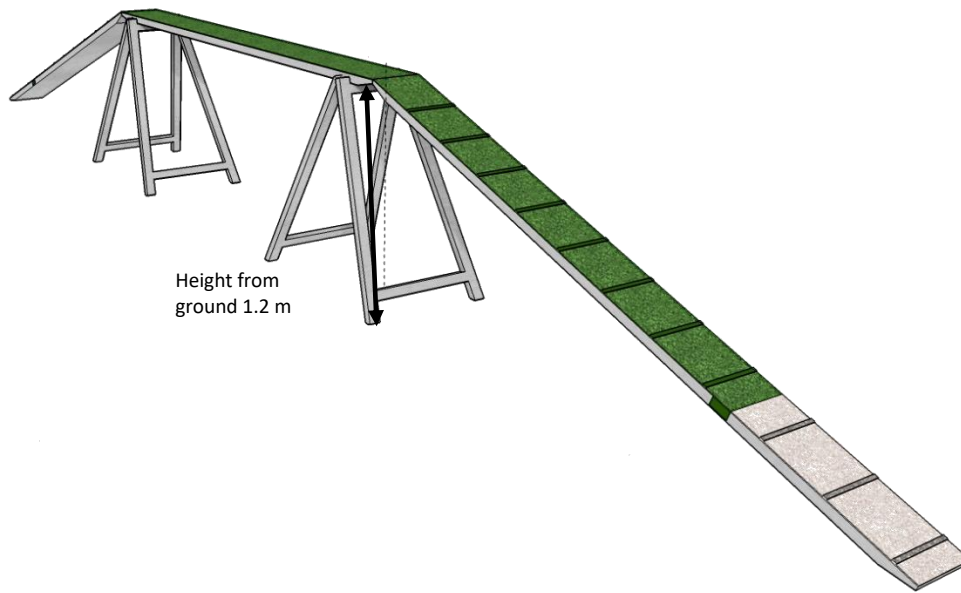

A walk plank of 1.2m measured from the ground to the top of the plank, with firmly fixed ramps at either end. The planks must be 3.66m in length and a minimum of 254mm and a maximum of 305mm in width.

The last 914mm from the bottom of each ramp should be a different colour to indicate the area with which the dog should make contact.

Each ramp should have a non-slip surface, and anti-slip slats at intervals but not within 152mm of the start of a contact area.

7.13.1 Positioning the dog walk

Entry onto the dog walk should be reasonably straight.

7.13.2 Marking for the dog walk

7.13.2.1 Faults

Five faults should be given if:

- The dog fails to make contact with the down contact area, the dog must touch the contact area with at least one paw or part of a paw.

Examples are shown in the diagram below.

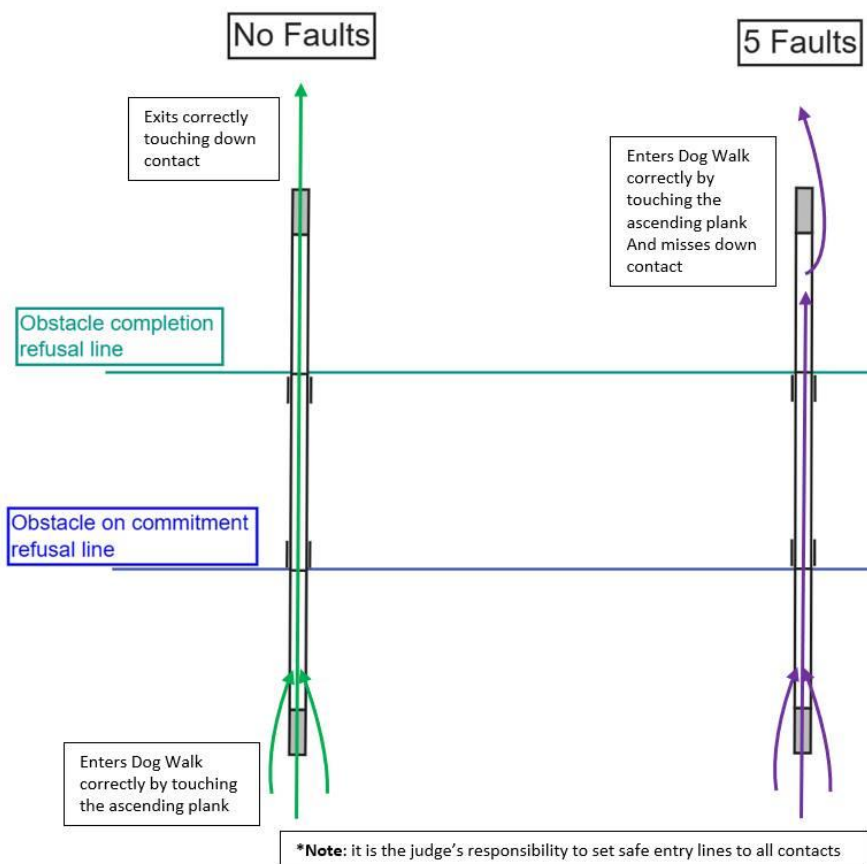

7.13.2.2 Refusals

A refusal should be given if the dog:

- Stops or turns away when in a position to take the obstacle
- Runs past the furthest point of the ascending ramp
- Alights before the down ramp or plank

7.13.2.3 Eliminations

An elimination should be given if the dog:

- Touches the obstacle from the wrong direction
- Leaves the obstacle, and then puts a paw back on the obstacle
- Fails to touch the ascending ramp

A judge should always ensure that they are in such a position that the down contact can be properly judged.

Examples are shown in the diagram below.

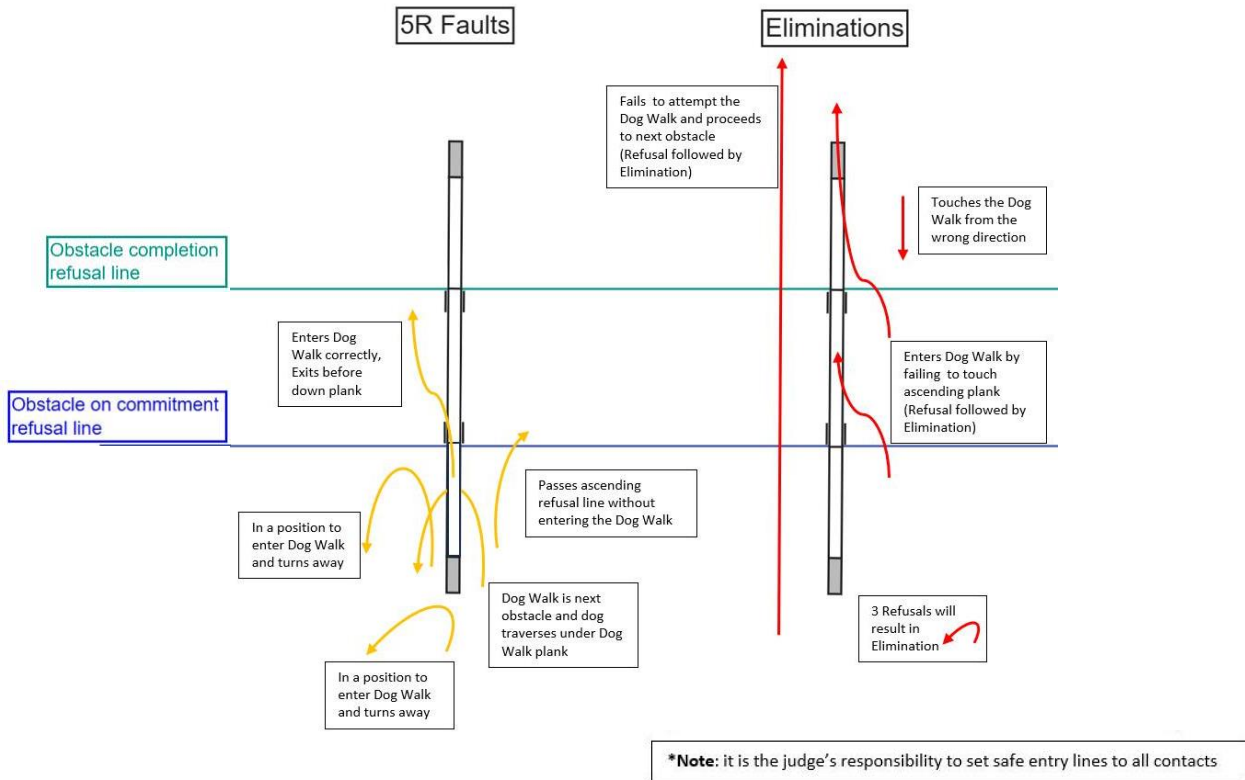

Obstacle on commitment refusal line: If the dog passes this point without entering the dog walk this would be faulted with a refusal.

Obstacle completion refusal line: This is the end of the top plank of the dog walk.

7.14 Positioning of contact obstacles

The entry onto all contact obstacles should be reasonably straight.

To help ensure a safe approach when designing courses, the judge should consider where the dog finishes the arc of its natural path from the previous obstacles and is now travelling in a straight line.

The contact obstacle should not force the dog to straighten its natural path. If the previous obstacle is a tunnel it is recommended to have at least the last 1.5m of the tunnel in a straight line with the contact.

Examples of safe line and unsafe lines onto contact equipment is illustrated in the diagrams below.

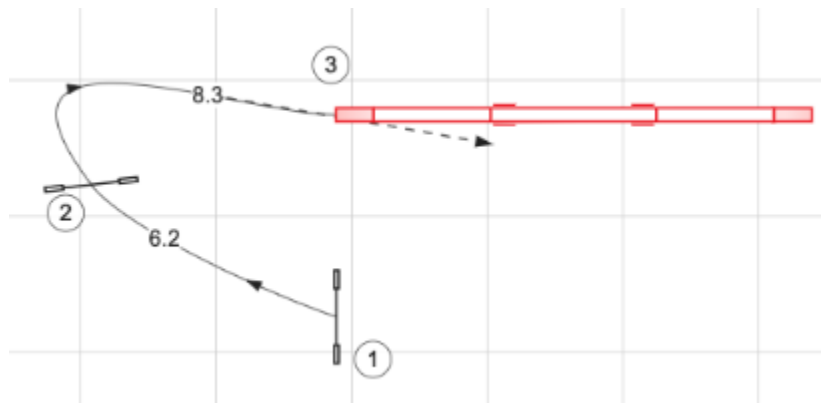

UNSAFE

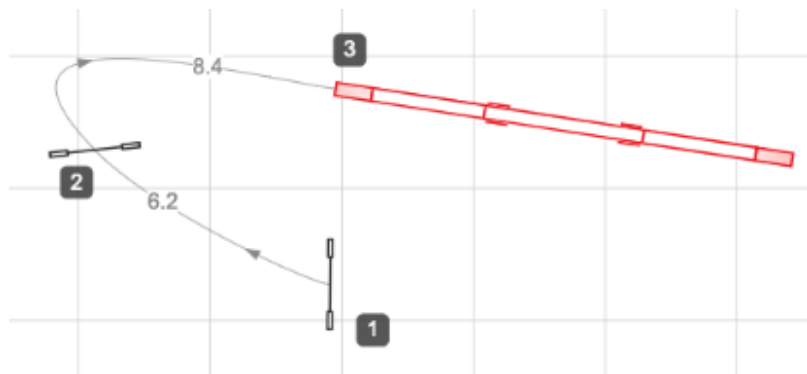

SAFE

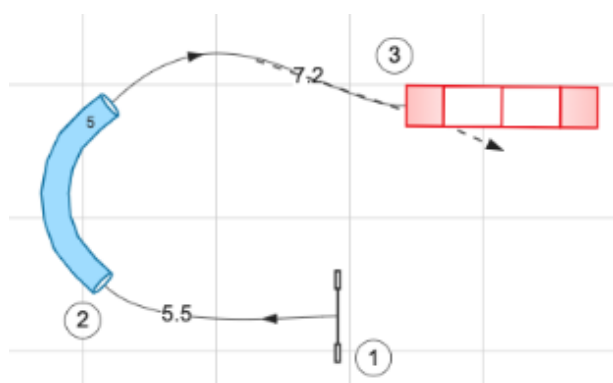

UNSAFE

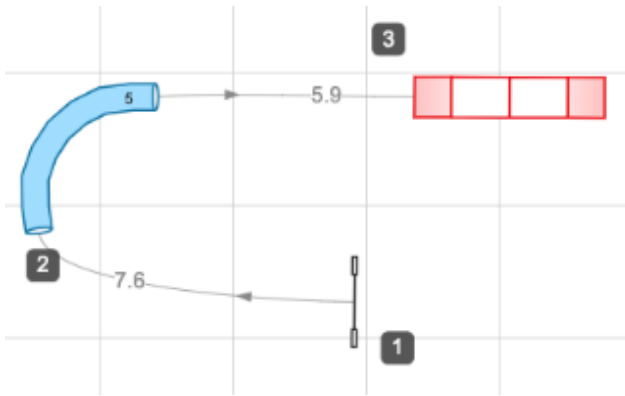

SAFE

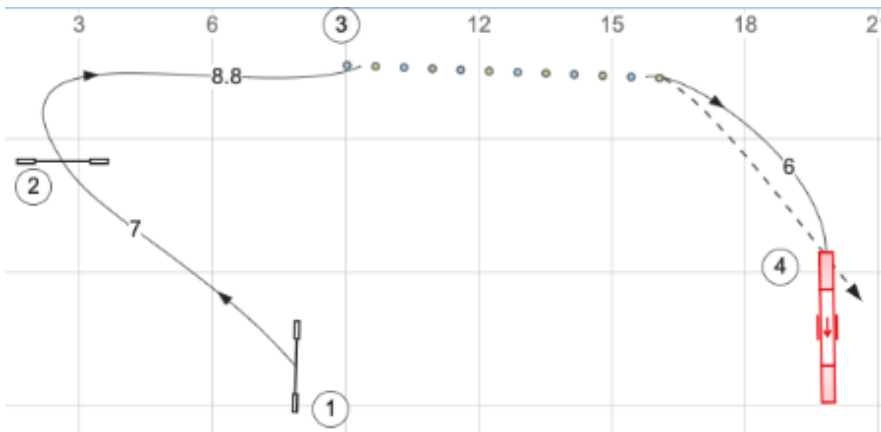

UNSAFE

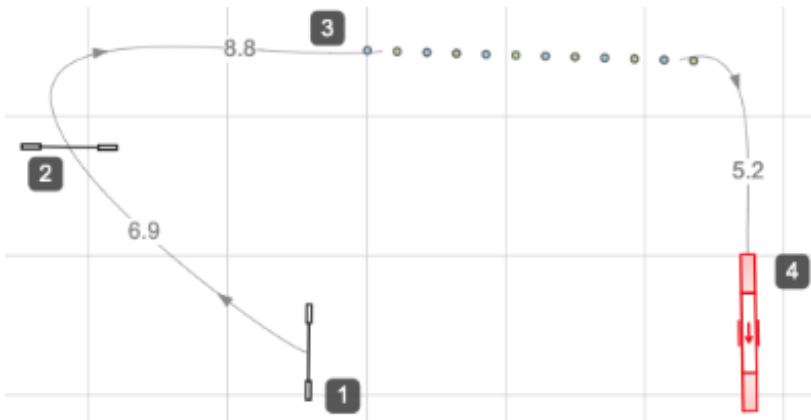

SAFE

7.15 Tolerances

All measurements of 1000mm or under may have a tolerance of plus or minus 5mm and measurements of over 1000mm may have a tolerance of plus or minus 10mm.

8 Championship classes

8.1 Becoming a championship judge

To become an agility championship judge a person must meet the following criteria:

- (1) have a minimum of 5 years' experience of competing at Kennel Club licensed agility shows, and
- (2) have a minimum of 5 years' experience of judging at Kennel Club licensed agility shows, and
- (3) have judged at a minimum of 10 licensed agility shows over the previous 3 years including standard classes in each height category which must include grade 7, class size and geographical distribution of judging appointments will be a consideration, and
- (4) have judged Kennel Club qualifier(s) for Crufts, Discover Dogs, or The Kennel Club Agility Stakes, and
- (5) have handled a dog competitively at grade 6 or 7, and
- (6) have been assessed before their first championship appointment, and
- (7) have completed and passed an agility judges examination on The Kennel Club Academy prior to attending a Kennel Club Judges Seminar, and
- (8) have attended a Kennel Club Agility Judges Seminar and passed the assessment, or
- (9) otherwise have been approved by the Board.

All first-time appointments must be applied for a minimum of eighteen months before the date of the championship show.

The three-part contract is also applicable to championship judging appointments. Championship judges may not judge another Championship Agility Certificate at the same height category within a period of six calendar months.

8.2 Obstacles to be used in championship classes

8.2.1 The agility round

Must contain the following elements: "A" Frame, Dog Walk, See-Saw, Hurdles, Tyre, Long Jump, Pipe Tunnel and Weaving Poles, together with any other approved obstacles as described in the Regulations at the discretion of the judge.

8.2.2 The jumping round

Must contain the following elements: Hurdles, Tyre, Long Jump, Pipe Tunnel and Weaving Poles and must exclude contact obstacles. It may include any other approved obstacles as listed above.

8.2.3 The final agility round

Must contain all the obstacles as the Agility round, together with any other approved obstacle as described in the regulations, at the discretion of the judge.

In the event of extreme adverse weather conditions at the show, the judge, with the full agreement of the competition manager, may alter the compulsory equipment as deemed appropriate at the time. Any alterations to the equipment must be reported by the management to The Kennel Club within 14 days of the date of the show.

8.3 Timing

Championship classes must use electronic timing. There must also be a backup timer in place. This is recorded manually. The electronic timing will always take precedence with the manual time only being recorded when the electronic timing has failed. A re-run cannot be offered if the electronic timing has failed and there is a manual time.

8.4 Calling for championship classes

Unlike other classes where handlers are required to run as close as possible to their running orders in a championship class handlers must run in their drawn order.

If there is a clash where for example a handler is drawn to run two dogs consecutively or is running dogs in two championship classes that are running at the same time the caller should keep the judge and other handlers informed of the situation. Only the judge can decide to have a short break to allow this handler to change dogs or move between rings. Handlers who do not present themselves ringside in the correct order will forfeit their run.

In exceptional circumstances the judge, in conjunction with the competition manager, may relax the running order, by no more than 10 dogs. All such decisions must be recorded in the incident book. This should be used to manage clashes when they occur and must not be in advance due to a perceived clash. The regulation applies to handlers with multiple dogs in the same class and handlers with dogs across multiple heights. This does not apply to the final round which must be run in strict running order.

The championship class always takes precedence over other classes, so the class should not be held up for a handler who is competing in another, non-championship class.

It is also important to note that the same handler & dog combination must run in all rounds of the championship class. The caller cannot, therefore, change the handler after the first round of the class.

9 Appendix A - Course Time Matrix

The Course Time Matrix should be used by judges as a guide to assist in setting course times. Once the judge has measured the course using the straight-line method the judge should use the chart to guide them to the recommended course time according to the chart. The time given in the chart will normally be a range. The judge should also consider the range of grades in the class, especially in combined classes.

For example: the course time for a Large Grade 3 agility course of 115 metres will be 38 - 42 seconds. The more flowing the course, the faster the dog will be, so choose towards 38 seconds. The more complex, the slower the dog so choose towards 42 seconds.

Judges are advised not to increase the recommended course time from that given in the matrix unless there are exceptional conditions on the day that would make this necessary.

This course time matrix will be kept under review and revised if data suggests it is needed.

Agility Course Time Matrix							
Course Length in Metres	Recommended Course Time in Seconds						
	95	42	38	35	32	29	27
100	44	40	36	33	31	29	27
105	47	42	38	35	32	30	28
110	49	44	40	37	34	31	29
115	51	46	42	38	35	33	31
120	53	48	44	40	37	34	32
125	56	50	45	42	38	36	33
130	58	52	47	43	40	37	35
135	60	54	49	45	42	39	36
140	62	56	51	47	43	40	37
142	63	57	52	47	44	41	38
145	64	58	53	48	45	41	39
148	66	59	54	49	46	42	39
150	67	60	55	50	46	43	40
152	68	61	55	51	47	43	41
155	69	62	56	52	48	44	41
158	70	63	57	53	49	45	42
160	71	64	58	53	49	46	43
162	72	65	59	54	50	46	43
165	73	66	60	55	51	47	44
168	75	67	61	56	52	48	45
170	76	68	62	57	52	49	45
172	76	69	63	57	53	49	46
175	78	70	64	58	54	50	47
178	79	71	65	59	55	51	47
180	80	72	65	60	55	51	48
182	81	73	66	61	56	52	49
185	82	74	67	62	57	53	49
188	84	75	68	63	58	54	50
190	84	76	69	63	58	54	51
192	85	77	70	64	59	55	51
195	87	78	71	65	60	56	52
198	88	79	72	66	61	57	53
200	89	80	73	67	62	57	53
202	90	81	73	67	62	58	54
205	91	82	75	68	63	59	55
208	92	83	76	69	64	59	55
210	93	84	76	70	65	60	56
212	94	85	77	71	65	61	57
215	96	86	78	72	66	61	57
220	98	88	80	73	68	63	59
225	100	90	82	75	69	64	60
230	102	92	84	77	71	66	61
235	104	94	85	78	72	67	63
240	107	96	87	80	74	69	64
Large		1	1,2,3	2,3,4,5,6	4,5,6,7	7,Ch	Ch
Intermediate		1	1,2,3	2,3,4,5,6	4,5,6,7	7,Ch	Ch
Medium	1,2	1,2,3,4	3,4,5,6	5,6,7	7,Ch	Ch	
Small	1,2	1,2,3,4	3,4,5,6	5,6,7	7,Ch	Ch	

Jumping Course Time Matrix

Course Length in Metres	Recommended Course Time in Seconds							
	95	42	38	35	32	29	27	25
100	44	40	36	33	31	29	27	25
105	47	42	38	35	32	30	28	26
110	49	44	40	37	34	31	29	28
115	51	46	42	38	35	33	31	29
120	53	48	44	40	37	34	32	30
125	56	50	45	42	38	36	33	31
130	58	52	47	43	40	37	35	33
135	60	54	49	45	42	39	36	34
140	62	56	51	47	43	40	37	35
142	63	57	52	47	44	41	38	36
145	64	58	53	48	45	41	39	36
148	66	59	54	49	46	42	39	37
150	67	60	55	50	46	43	40	38
152	68	61	55	51	47	43	41	38
155	69	62	56	52	48	44	41	39
158	70	63	57	53	49	45	42	40
160	71	64	58	53	49	46	43	40
162	72	65	59	54	50	46	43	41
165	73	66	60	55	51	47	44	41
168	75	67	61	56	52	48	45	42
170	76	68	62	57	52	49	45	43
172	76	69	63	57	53	49	46	43
175	78	70	64	58	54	50	47	44
178	79	71	65	59	55	51	47	45
180	80	72	65	60	55	51	48	45
182	81	73	66	61	56	52	49	46
185	82	74	67	62	57	53	49	46
188	84	75	68	63	58	54	50	47
190	84	76	69	63	58	54	51	48
192	85	77	70	64	59	55	51	48
195	87	78	71	65	60	56	52	49
198	88	79	72	66	61	57	53	50
200	89	80	73	67	62	57	53	50
202	90	81	73	67	62	58	54	51
205	91	82	75	68	63	59	55	51
208	92	83	76	69	64	59	55	52
210	93	84	76	70	65	60	56	53
212	94	85	77	71	65	61	57	53
215	96	86	78	72	66	61	57	54
220	98	88	80	73	68	63	59	55
220	98	88	80	73	68	63	59	55
225	100	90	82	75	69	64	60	56
228	101	91	83	76	70	65	61	57
230	102	92	84	77	71	66	61	58
Large			1	1,2	2,3,4	3,4,5,6,7	7, Ch	Ch
Intermediate			1	1,2	2,3,4	3,4,5,6,7	7, Ch	Ch
Medium	1	1,2	2,3,4	3,4,5,6	5,6,7	7, Ch	Ch	
Small	1	1,2	2,3,4	3,4,5,6	5,6,7	7, Ch	Ch	

10 Appendix B – Quick reference guide

		LARGE	INTERMEDIATE	MEDIUM	SMALL	NOTES
HURDLE	Height	600 mm	500 mm	400 mm	300 mm	Minimum width 1.2m Minimum height of wing (inside) 900 mm
<i>(also covers wall & brush jump)</i>						
SPREAD JUMP	Height of back pole	600 mm	500 mm	400 mm	300 mm	No more than 2 elements are permitted Feet of elements must not interlock Elements can be out of line up to a max. of 75 mm
	Height of front pole	400 mm	300 mm	300 mm	200 mm	
	Maximum Spread	550 mm	475 mm	400 mm	300 mm	
TYRE	Centre of Aperture from the ground	800 mm	650 mm	550 mm	490 mm	Minimum diameter of aperture is 533 mm
LONG JUMP	Number of Units	5	4	3	2	Height of front unit 127 mm
	Units	1, 2, 3, 4 & 5	1, 2, 3 & 4	1, 2 & 3	1 & 2	
	Height of last unit	381 mm	305 mm	229 mm	170 mm	Minimum width of obstacle 1.2m
	Length of spread (Min - Max)	1.3 - 1.5 m	1.0 - 1.2 m	700 - 900 mm	400 - 600 mm	
DOG WALK	Height: 1.2 m	Each plank 3.66 m		Contact Area is the last 914 mm of each contact on the dog walk and see-saw and 1.067m on the A frame		
A FRAME	Height: 1.7m	Each ramp 2.74m				
SEE-SAW	Height at pivot 610 mm	Length of plank 3.66 m				
TUNNEL	Diameter 600 mm	Minimum length 3m		Tunnels may only curve in one direction		
WEAVES	Number of poles in a set is 6 or 12 with a maximum of 12 poles in any course.		Poles must be 600mm apart		Poles must be 35 mm in diameter and a minimum height of 762 mm	
DISTANCE BETWEEN OBSTACLES		5m - 10m measured using straight line technique				
TOLERANCES		All measurements of 1000mm or under may have a tolerance of plus or minus 5mm and measurements of over 1000mm may have a tolerance of plus or minus 10mm				

RING SIZE	Recommended Total Area	Minimum Total Area	Minimum length of each side
Standard and Special classes			
- Outdoor Rings - unenclosed areas	1024 m ²	1024 m ²	No side less than 32m
- Indoor Rings - irrespective of surface	600 m ²	450 m ²	No side less than 15m
- Outdoor rings - permanently enclosed	800 m ²	600m ²	No side less than 20 m
Prestige & championship events			
- held in outdoor rings		1024 m ²	No side less than 32m
- held in indoor or permanently enclosed rings		800 m ²	No side less than 20 m
SPACE BETWEEN RINGS/RING BARRIER TYPES			
<ul style="list-style-type: none"> - Minimum space between adjacent rings marked only with single ropes – 5m - If distance is less than 5m – at least one ring must have a visible barrier (i.e. netting) - Entrances and exits should not be opposite each other 			